

# Lovibond® Water Testing

Tintometer® Group



## Photometer XD 7000



**Instruction manual**

EN

[www.lovibond.com](http://www.lovibond.com)

**Copyright** © 2018, Tintometer GmbH  
Printed in Germany.

## Table of contents

<b>1</b>	<b>Safety</b> .....	<b>7</b>
1.1	General instructions .....	7
1.2	Safety information .....	7
1.2.1	Safety information in the operating manual .....	7
1.2.2	Safety signs on the product .....	8
1.2.3	Further documents providing safety information .....	8
1.3	Safe operation .....	8
1.3.1	Authorized use .....	8
1.3.2	Requirements for safe operation .....	8
1.3.3	Unauthorized use .....	8
1.4	User qualification .....	9
1.5	Handling of hazardous substances .....	9
<b>2</b>	<b>Overview</b> .....	<b>11</b>
2.1	Overview of the instrument .....	11
2.2	Keypad .....	12
2.3	Display .....	13
<b>3</b>	<b>Commissioning</b> .....	<b>15</b>
3.1	Scope of delivery .....	15
3.2	General notes on handling .....	15
3.3	Initial commissioning .....	16
3.3.1	Inserting the buffer batteries .....	16
3.3.2	Connecting the power supply .....	17
3.3.3	Switching on the photometer for the first time .....	17
3.3.4	Setting the language .....	18
3.3.5	Setting the date and time .....	18
3.4	Connecting optional accessories .....	20
3.4.1	Communication interfaces .....	20
3.4.2	PC/printer .....	21
3.4.3	USB memory device .....	21
3.4.4	PC keyboard .....	22
3.4.5	Barcode reader .....	22
3.4.6	Operation with a 12 V vehicle connection cable .....	23

<b>4</b>	<b>Operation</b>	<b>25</b>
4.1	Switching on or off the photometer	25
4.2	General operating principles	27
4.2.1	Navigating with function keys and menus	27
4.2.2	Display of navigation paths in short form	28
4.2.3	Entry of numerals, letters and characters	30
4.2.4	Detailed operating example: Changing the language	31
4.2.5	Inserting a cell	32
4.2.6	Usable cells	34
4.3	Photometer settings and system administration	34
4.3.1	Language	34
4.3.2	Date/Time	35
4.3.3	Display settings	36
4.4	Zero adjustment	36
4.5	Measuring in <i>Concentration</i> mode	40
4.5.1	Measuring cell tests with barcode	40
4.5.2	Measuring reagent tests, external barcode reader	41
4.5.3	Measuring user-defined methods	42
4.5.4	Exceeding the upper or lower limits of the measuring range	43
4.5.5	Selecting a method manually	44
4.5.6	Settings for <i>Concentration</i> mode	45
4.5.7	Measuring diluted samples	46
4.5.8	Sample blank value	48
4.5.9	Reagent blank value	50
4.5.10	User calibration (standard adjustment)	54
4.5.11	Automatic Turbidity correction	61
4.5.12	Programming / modifying user-defined methods	61
4.6	Measuring the Absorbance / % Transmission	72
4.6.1	General information	72
4.6.2	Measuring the absorbance or transmission	72
4.6.3	Measuring against the Reference absorbance	73
4.7	Special / Multi wavelengths methods	76
4.7.1	Basic information on Special / Multi wavelengths measurements	76
4.7.2	Programming / modifying the Special / Multi wavelengths methods	76
4.7.3	Selecting a Special / Multi wavelengths method	83
4.7.4	Carrying out Special / Multi wavelengths measurements	84
4.8	Spectrum	87
4.8.1	General information	87
4.8.2	Recording a Spectrum	88
4.8.3	Loading/editing a spectrum	90
4.8.4	Saving / exporting a spectrum	93

---

4.9	Kinetics	95
4.9.1	Creating/editing profiles for Kinetics recordings	95
4.9.2	Loading profile for Kinetics recording	98
4.9.3	Recording Kinetics	99
4.9.4	Saving/exporting a Kinetics recording	101
4.9.5	Loading a Kinetics recording	102
4.9.6	Editing a Kinetics recording	103
4.10	Timer	106
4.10.1	<i>User defined timer</i>	106
4.10.2	Analysis timer	107
4.11	Memory	109
4.11.1	Overview	109
4.11.2	Instructions on using USB memory devices	110
4.11.3	Measurement datasets	110
4.11.4	Saving measurement datasets manually	111
4.11.5	Saving measurement datasets automatically	112
4.11.6	Displaying measurement data memory	113
4.11.7	Filtering measurement datasets	114
4.11.8	Inverting filters	116
4.11.9	Erasing stored measurement datasets	117
4.11.10	Saving kinetics recordings, spectra and DeviceCheck files	118
4.11.11	Saving data as a pdf file	118
4.12	Saving / exporting files	119
4.12.1	Copying all measurement data files to a USB memory device	119
4.12.2	Copying user-defined methods / profiles to a USB memory device	120
4.12.3	Copying files to a PC	121
4.12.4	Accessing photometer files via Ethernet	122
4.13	Importing files	124
4.13.1	Importing spectra or kinetic recordings from a USB memory device	124
4.13.2	Importing methods / profiles from a USB memory device	124
4.14	Printing the data (USB)	126
4.14.1	Printer and terminal programs	126
4.14.2	Settings for data transmission	126
4.14.3	Printing measurement datasets	127
4.14.4	Printing spectra or Kinetics records	128
4.15	Quality assurance of the results (DeviceCheck)	129
4.15.1	General information	129
4.15.2	Checking of photometer (PCheck)	129
4.15.3	Checking photometer and method (MCheck)	135
4.15.4	Checking the sample for matrix influence (SCheck)	139
4.16	User management	145
4.16.1	User levels and user rights	145
4.16.2	Activating or deactivating the User management function	146
4.16.3	Creating, changing or deleting a user account	147
4.16.4	Login with active user management	149
4.16.5	Changing the password	150

---

4.17	Reset	151
4.18	Photometer information ([Info])	152
4.19	Lamp counter	152
4.20	Software and methods update	153
4.20.1	Software- and method update using a USB memory device	153
4.20.2	Remote functions	154
<b>5</b>	<b>Maintenance and cleaning</b>	<b>155</b>
5.1	Replacing the lamp	155
5.2	Exchanging the buffer battery	156
5.3	Cleaning	158
5.3.1	Cleaning the enclosure	158
5.3.2	Cleaning the cell shaft	158
5.3.3	Cleaning the detector lens	159
<b>6</b>	<b>What to do if...</b>	<b>160</b>
6.1	Actions in the case of a broken cell	160
6.2	Error causes and remedies	161
<b>7</b>	<b>Technical data</b>	<b>164</b>
7.1	Measurement characteristics	164
7.2	Measured value documentation and quality assurance	166
7.3	General meter data	167
<b>8</b>	<b>Accessories and options</b>	<b>170</b>
8.1	Accessories	170
8.2	Test equipment	171
8.3	Optional equipment	171
8.4	Connection cable:	171
<b>9</b>	<b>Appendix</b>	<b>172</b>
9.1	Glossary	172
9.2	List of trademarks	174
9.3	Keyword index	175

# 1 Safety

## 1.1 General instructions

The manufacturer's liability and warranty for damage and consequential damages lapses with improper use, failure to follow this operating manual, use of insufficiently qualified specialized personnel or unauthorized changes to the instrument.

The manufacturer is not liable for costs or damages that arise for the user or third parties due to the use of this instrument, especially in case of improper use of the instrument or misuse or faults in the connection or of the instrument.

The manufacturer assumes no liability for print errors.

## 1.2 Safety information

### 1.2.1 Safety information in the operating manual

This operating manual provides important information on the safe operation of the product. Read this operating manual thoroughly and make yourself familiar with the product before putting it into operation or working with it. The operating manual must be kept in the vicinity of the product so you can always find the information you need.

Important safety instructions are highlighted in this operating manual. They are indicated by the warning symbol (triangle) in the left column. The signal word (e.g. "CAUTION") indicates the level of danger:



#### **WARNING**

indicates a possibly dangerous situation that can lead to serious (irreversible) injury or death if the safety instruction is not followed.



#### **CAUTION**

indicates a possibly dangerous situation that can lead to slight (reversible) injury if the safety instruction is not followed.

#### **NOTE**

*indicates a situation where goods might be damaged if the actions mentioned are not taken.*

### 1.2.2 Safety signs on the product

Note all labels, information signs and safety symbols on the product. A warning symbol (triangle) without text refers to safety information in this operating manual.

### 1.2.3 Further documents providing safety information

The following documents provide additional information, which you should observe for your safety when working with the measuring system:

- Operating manuals of other components of the XD 7000 (accessories)
- Safety datasheets for chemicals.

## 1.3 Safe operation

### 1.3.1 Authorized use

The authorized use of the photometer consists exclusively of the carrying out of photometric measurements according to this operating manual. Follow the technical specifications of the cells in Chapter 7 TECHNICAL DATA. Any other use is considered **unauthorized**.

### 1.3.2 Requirements for safe operation

Note the following points for safe operation:

- The product may only be operated according to the authorized use specified above.
- The product may only be supplied with power by the energy sources mentioned in this operating manual.
- The product may only be operated under the environmental conditions mentioned in this operating manual.
- The product may not be opened.

### 1.3.3 Unauthorized use

The product must not be put into operation if:

- it is visibly damaged (e.g. after being transported)
- it was stored under adverse conditions for a lengthy period of time (storing conditions, see Chapter 7 TECHNICAL DATA).



## 1.4 User qualification

Carrying out photometric determinations with the aid of test sets frequently requires the handling of hazardous substances.

We assume that the operating personnel know how to handle hazardous substances due to their professional training and experience. The operating personnel must particularly be able to understand and correctly implement the safety labels and safety instructions on the packages and inserts of the test sets.

## 1.5 Handling of hazardous substances

For the development of test sets, Tintometer pays close attention to as safe an execution as possible. Some hazards by dangerous substances, however, cannot always be avoided.

If self-produced tests or solutions are used, the responsibility concerning any risks caused by those tests or solutions lies with the user (personal responsibility).



### **WARNING**

**Improper handling of certain reagents can cause damage to your health.**

**In any case follow the safety labels on the packing and the safety instructions of the package insert. Protective measures specified there have to be followed exactly.**

### **Safety datasheets**

The safety datasheets of the chemicals comprise all instructions on safe handling, occurring hazards, preventive actions and actions to take in hazardous situations. Follow these instructions in order to work safely.



## 2 Overview

### 2.1 Overview of the instrument

Front of the instrument

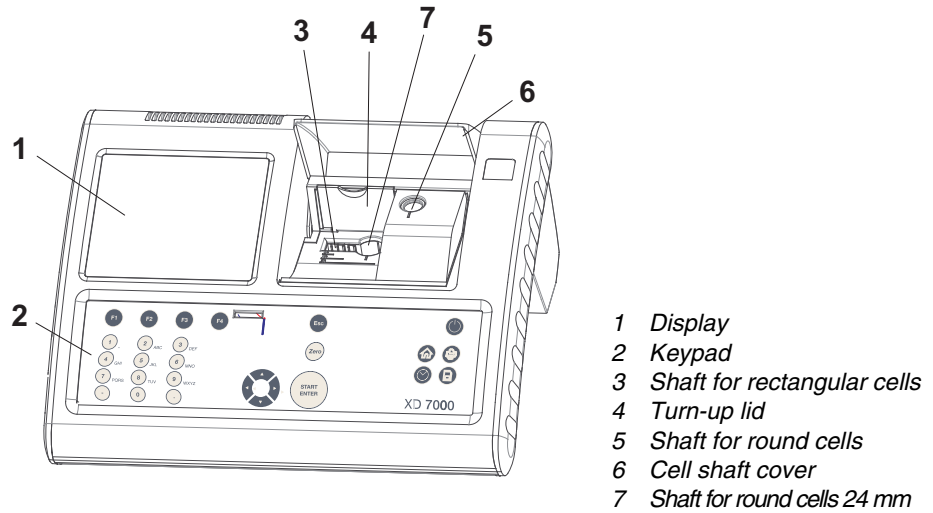

Figure 2-1 Front of the instrument with operating elements

Socket field on the rear panel

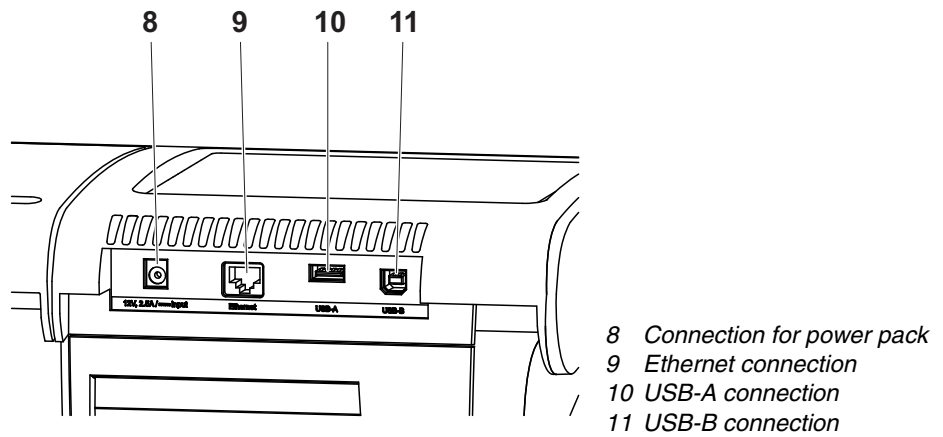

Figure 2-2 Rear panel with socket field



All connections comply with SELV.

## 2.2 Keypad

### Overview

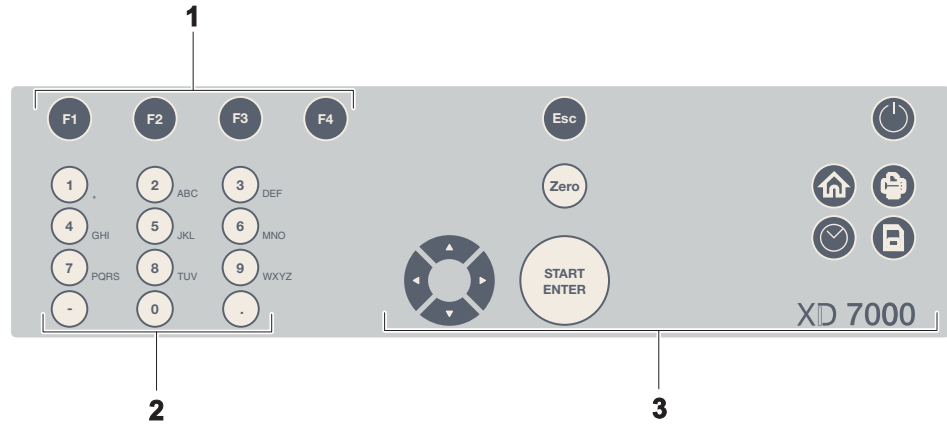









- 1 Function keys F1 to F4 (function menu-dependent)
- 2 Alphanumeric keypad
- 3 Keys with dedicated function

Figure 2-3 Keypad

### Key functions

The keys on the right side of the keypad have the following functions:

Key	Designation	Functions
	<b>&lt;ON/OFF&gt;</b>	– Switches on and off the photometer
	<b>&lt;HOME&gt;</b>	– Switches to the main menu from any operating situation. Actions that are not completed are canceled.
	<b>&lt;PRINT&gt;</b>	– Outputs the measured value displayed in an interface, if the <i>Printer</i> symbol is displayed on the status line.
	<b>&lt;STORE&gt;</b>	– Saves a displayed measured value or spectrum if the <i>Save</i> symbol is displayed in the status line.
	<b>&lt;ZERO-BLANK&gt;</b>	– Starts one of the following measurements, depending on the operating situation: - Zero adjustment - Blank value measurement - Baseline measurement - User calibration
	<b>&lt;TIMER&gt;</b>	– Opens the menu, <i>Timer</i> .

Key	Designation	Functions
	<ESC>	<ul style="list-style-type: none"> <li>– Cancels the running action. Entries that have not yet been accepted are discarded.</li> <li>– Switches to the next higher menu level.</li> </ul>
	<START·ENTER>	<ul style="list-style-type: none"> <li>– Starts an action (e.g. measurement)</li> <li>– Opens a selected menu</li> <li>– Confirms a selection or entry</li> <li>– Corresponds to the "Test" key in the method description</li> </ul>
 (Arrow keys)	<▲> or <▼>	– Moves the selection in menus and lists one position up or down
	<◀>	<ul style="list-style-type: none"> <li>– Deletes the character left of the cursor during character entries</li> <li>– Moves the cursor to the left in a spectrum or kinetic diagram</li> </ul>
	<▶>	– Moves the cursor to the right in a spectrum or kinetic diagram

**Function keys**

The function keys F1 to F4 have different functions depending on the operating situation. The current functions are displayed in the function key menu at the bottom edge of the display (see Section 4.2.1).

**2.3 Display**

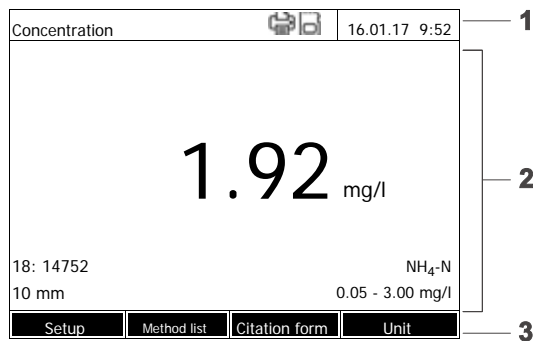

**Display elements**



- 1 Status line (current state, date and time)
- 2 Display range for menus and measurement results
- 3 Function keys menu

Figure 2-4 Display

**Symbols in the  
status line**

Symbol	Designation	Function
	<i>Save</i>	The <b>&lt;STORE&gt;</b> key is active. You can store the displayed data with <b>&lt;STORE&gt;</b> (see Section 4.11).
	<i>Printer</i>	The <b>&lt;PRINT&gt;</b> key is active. You can store the displayed data with <b>&lt;PRINT&gt;</b> (see Section 4.14).

## 3 Commissioning

### 3.1 Scope of delivery

- Spectrophotometer XD 7000
- Power pack with connection cable
- Buffer batteries 4 x AA alkaline manganese (Mignon)
- Two zero cells (16 mm and 24 mm, round)
- Four cells 24 mm, round
- Five plastic stirring rods, 13 cm
- Compact instructions (5 languages)
- Brief instructions (27 languages)
- USB stick with
  - Brief instructions (27 languages)
  - Detailed operating instructions (8 languages)
  - Current version of firmware and method update
  - Method manual

#### Packing

This photometer is sent out in a protective transport packing.



#### CAUTION

**Keep the original packing including the inner packing to protect the instrument against hard shocks if it has to be transported.**

**The original packing is also required for the proper return of the instrument if it has to be repaired.**

**Note that damage caused by improper transport voids all warranty claims.**

### 3.2 General notes on handling

Always protect the meter from conditions that could damage the mechanical, optical and electronic components. Heed the following points especially:

- The temperature and humidity during operation and storage must be within the limits specified in Chapter 7 TECHNICAL DATA.
- The following influences always have to be avoided with the meter:
  - Extreme dust, moisture and wetness
  - Exposure to intensive light and heat
  - Fumes that are corrosive or contain high concentrations of solvents.
- For measuring, the meter must be placed on a flat surface.
- Spilled liquid or other material should be removed immediately (see Sec-

tion 5.3 CLEANING or Section 6.1 ACTIONS IN THE CASE OF A BROKEN CELL).

- The cell shaft should always be closed when the photometer is not used.
- For the instrument to be transported the cell shaft has to be empty.
- For mobile use, we recommend the transport case (item no. 71310010, see Section 8.1 ACCESSORIES).

### 3.3 Initial commissioning

Perform the following activities:

- Insert the buffer batteries (see Section 3.3.1)
- Connect the power supply (see Section 3.3.2)
- Switch on the photometer (see Section 3.3.3)
- Set the language (see Section 3.3.4)
- Set the date and time (see Section 3.3.5)
- Carry out a zero adjustment (see Section )



If you set the language, date and time using sections 3.3.4 and 3.3.5, you will soon become acquainted with the easy operation of the XD 7000. More detailed instructions on operation are given in Section 4.2 GENERAL OPERATING PRINCIPLES.

#### 3.3.1 Inserting the buffer batteries

Four buffer batteries (type AA or Mignon, included in the scope of delivery) supply the integrated clock with power while the photometer is switched off.

Insert the batteries as follows:

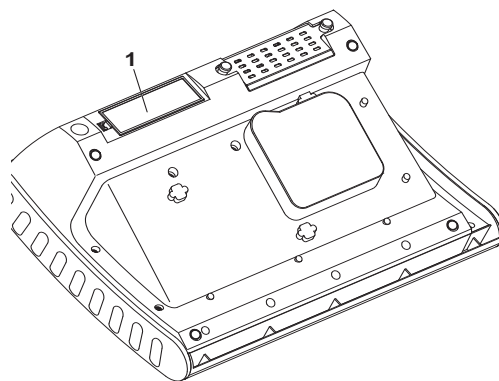

- 1 Turn the photometer upside down and place it on a soft surface.
- 2 Open the lid of the battery compartment (1).
- 3 Insert the four batteries in the battery compartment. Make sure that the poles of the batteries are in the correct position.
- 4 Close the lid of the battery compartment.



**Battery service life**

The power consumption of the clock is very low. The lifetime of high quality batteries is at least 5 years.

**3.3.2 Connecting the power supply**

The power is supplied with the aid of the enclosed plug-in power pack. The power pack supplies the photometer with low voltage (12 VDC).

**CAUTION**

**The line voltage of the usage location must fulfill the specifications stated on the power pack (the specifications are also given in Chapter 7 TECHNICAL DATA). Always use the supplied 12 V original power pack only.**

**Before plugging in the power cable check whether it is undamaged. If the power cable is damaged, the instrument must not be operated.**

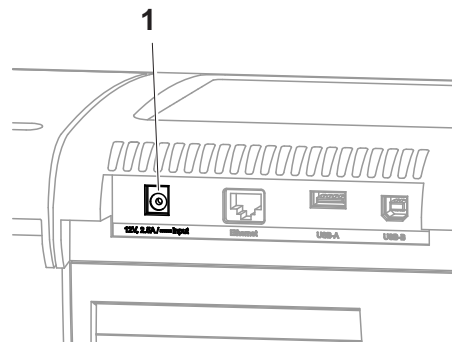
**Connect the power pack**

- 1** Connect the miniplug of the power pack to the socket (1) of the photometer.
- 2** Connect the power pack to a power outlet.

The display illumination switches itself on and then off again.

**For operation with a mobile 12 V- power supply unit**

You can also operate the XD 7000 on the move and independent of the local power supply.

For this, you need a 12 V power supply unit such as, e.g. our 12 V portable power source (item no. 711050) or our 12 V auto connection cable (item no. 71310020) (see Section 3.4.6).

**3.3.3 Switching on the photometer for the first time**

During the initial commissioning, the photometer automatically guides you through the setting of the meter language, date and time after switching on (see following sections).

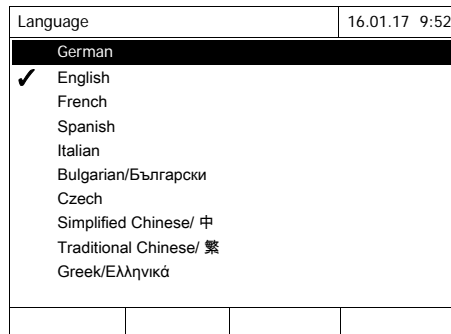

1 Press **<ON/OFF>**.

The photometer is switched on.

The display switches to the setting of the language (see Section 3.3.4).

After the setting of the language the photometer carries out the self-test.

When the initial commissioning is completed, the photometer displays the *Home* menu each time after it is switched on and after the self-test (see Section 4.1).

### 3.3.4 Setting the language

During the initial commissioning the photometer automatically guides you to the setting of the meter language after switching on.

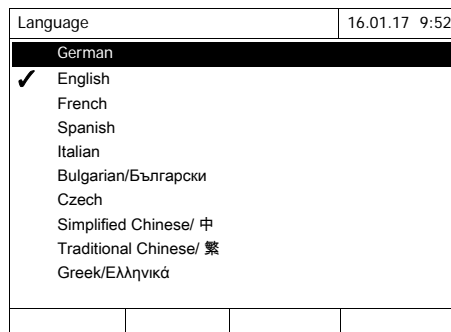

1 Select a language with **<▲><▼>**.

2 Confirm the selected language with **<START-ENTER>**.

The language has been set. The currently selected language has a checkmark.

The display switches to the setting of the *Date* and *Time* (see Section 3.3.5).

After the initial commissioning, you can change the language in the *General setup / Language* menu at any time (see Section 4.2.4).

### 3.3.5 Setting the date and time

During the initial commissioning, the instrument automatically guides you to the setting of the time and date after the setting of the language.

Date/Time	16.01.17 9:52
Date	16.01.2017
Time	9:52:09
OK	

The *Date/Time* menu opens.

Select a menu item with **<▲><▼>** and confirm or open with **<START-ENTER>**.

- 1 Select and confirm *Date*.

The input field for the current date pops up.

Date/Time	16.01.17 9:52
Date	16.01.2017
Time	9:52:09
OK	

Date

16 .01.2017

- 2 Enter the current date with **<0...9>** and confirm.

The input field closes.  
The date is accepted.

- 3 Select and confirm *Time*.

The input field for the current time pops up.

Date/Time	16.01.17 9:52
Date	16.01.2017
Time	9:52:09
OK	

Time

09 : 52 : 09

- 4 Enter the current time with **<0...9>** and confirm.

The input field closes.  
The time is accepted.

After the initial commissioning, you can change the date and time in the *General setup / Date/Time* menu at any time (see Section 4.2.4).

### 3.4 Connecting optional accessories

#### 3.4.1 Communication interfaces

##### Connections

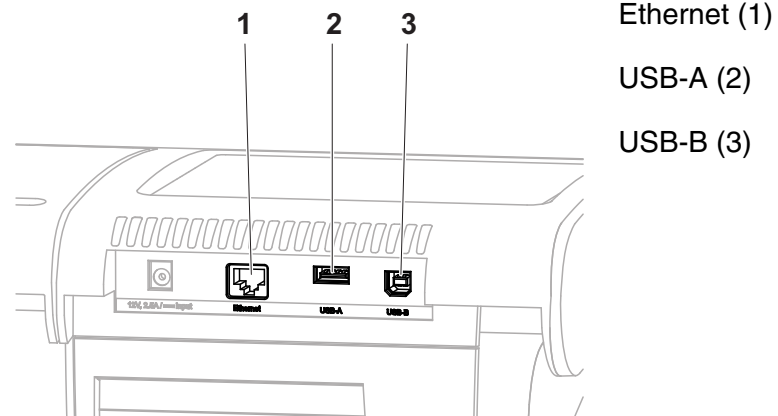

Figure 3-1 Communication interfaces on the rear panel

You can connect the following accessories to the photometer:

- PC (see Section 3.4.2)
- Printer (see Section 3.4.2)
- USB storage media (see Section 3.4.3)
- USB-PC keyboard (see Section 3.4.4)
- Barcode reader (see Section 3.4.5)
- 12 V auto charging cable (see Section 3.4.6)



The number of USB-A sockets can be increased with a commercially available USB-2 hub with separate power supply.

### 3.4.2 PC/printer

PC and printer can be connected to the photometer as follows:

Interface	PC	Printer	Functions
USB-A		✓	The data is printed out with <b>&lt;PRINT&gt;</b> .
USB-B	✓	-	Enables the direct connection of photometer and PC. With this you can transmit measurement data to the PC (see Section 4.12Section 4.14) or update the photometer software (see Section 4.20.1).  After connection to the PC, you can access the instrument as you would a USB storage medium, in order to copy data and files on the PC.



Suitable are PCL compatible printers (for details, see Section 4.14.1 PRINTER AND TERMINAL PROGRAMS).

### 3.4.3 USB memory device

Using a USB memory device (such as a USB flash drive), you can

- Update the meter software and method data (Section 4.20)
- transmit data to the USB memory device (Section 4.11 and Section 4.12).

USB memory devices are connected to the USB-A interface.



Please note the instructions for use of USB storage media (see Section 4.11.2).

### 3.4.4 PC keyboard

With the PC keyboard it is possible to enter letters, e.g. to assign names for identification (ID).

In addition, the following keys of the PC keyboard are assigned with the following functions of the photometer:

Photometer	PC keyboard
<START-ENTER>	Enter
<ESC>	Esc
<F1> to <F4> (function keys)	F1 to F4
<▲><▼><◀><▶> (arrow keys)	Arrow keys
<HOME>	F5
<PRINT>	F6
<STORE>	F7
<ZERO-BLANK>	F8
<TIMER>	F9
<ON/OFF>	F12
Symbols and characters according to the operating manual	Corresponding key on the keyboard
0..9	0..9
-	-
.	.

The USB-PC keyboard is connected to the USB-A interface.

### 3.4.5 Barcode reader

The barcode reader enables the simplified entering of alphanumeric character strings and can be used in all operating situations that require the entry of text or numerals. The barcode reader is connected to the USB-A interface.

In addition, the barcode reader can be used for method selection. There is a barcode for each method description. If the instrument is in concentration mode, the instrument jumps directly to the appropriate method after reading this barcode.

Method barcodes are in the respective method description, on reagent packaging, and you can download them from our website so that you can incorporate them into your work instructions.

You can get a compatible barcode reader under the item no. 71310030.



- Configure the barcode reader before operation with the photometer to use code 128 (see operating instructions for your barcode reader).
- Many barcode readers add a LF (Line Feed) or a CR (Carriage Return) control character when delivered from the factory. This setting causes malfunctions on the concentration menu of the spectrophotometer. In this case, change the setting of your barcode reader so that after the barcode read in, no suffix is transmitted via the USB interface (see operating instructions for the barcode reader).

### 3.4.6 Operation with a 12 V vehicle connection cable

With the 12 V vehicle connection cable (item no. 71310020) you can operate the spectrophotometer XD 7000 on the go and regardless of the local power supply.

To do so, a 12 V power supply such as a commercial 12 V portable power source or a 12 V car battery is required.

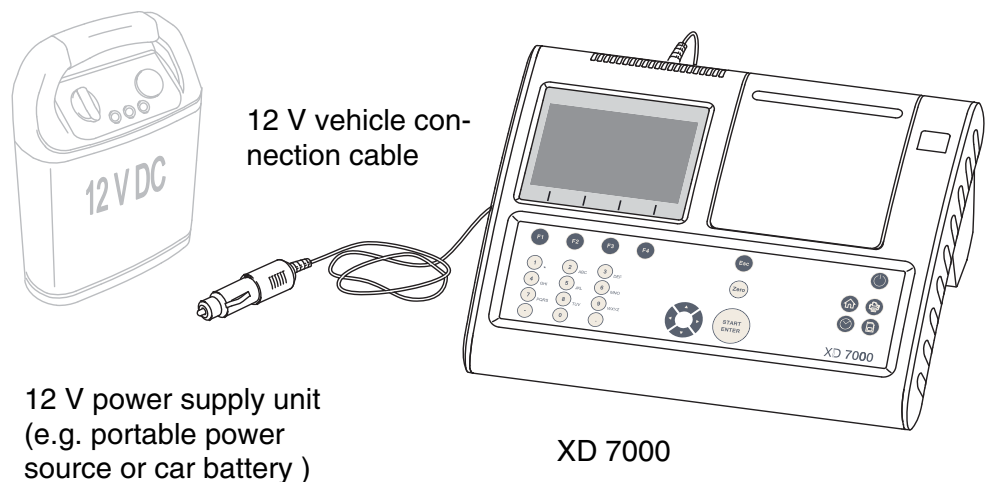

**Safety** For operation with an external battery, follow the safety instructions of the battery.  
Make sure that the power supply unit is suitable for the operation of the spectrophotometer (see technical data for the power supply unit and technical data for the spectrophotometer).

**Operating time with battery**

The maximum operating time depends on various factors:

- Battery (e.g. nominal capacity, condition, age)
- Operating mode of the spectrophotometer (e.g. frequency of measurements)
- Photometer (instrument type)

**Example**

Operating time with a type 12 V / 19 Ah battery in optimum condition: approx. 16 h



The spectrophotometer consumes electricity even while it is in standby mode.

With battery operation, we recommend you disconnect the vehicle connection cable while you are not using the photometer.

**12 V connection**

Suitable are connection cables with the following properties:

Voltage	12 V
Amperage	8 A
Barrel connector	2.5 x 5.5mm
Inner contact	Plus pole



## 4 Operation

### 4.1 Switching on or off the photometer

#### Switching on

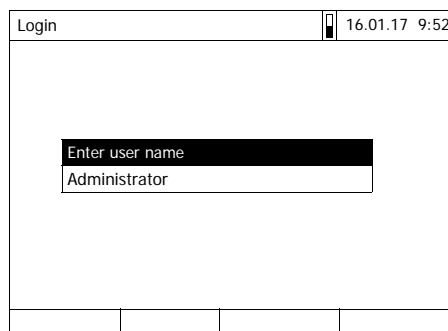
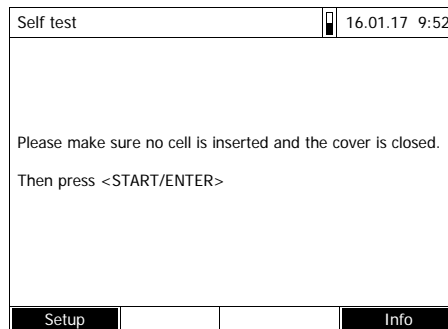

#### Starting the *Self test*

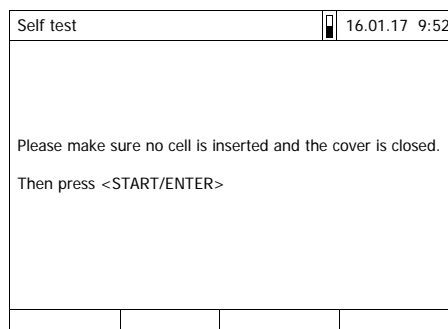

#### Self test

During the self-test, all cells must be removed and the cell shaft cover closed. The self-test runs in the background and may take some minutes.

- 1 Switch the photometer on with **<ON/OFF>**.

The display shows

- the *Self test* dialog (if the user management is not active).

or

- the *Login* dialog (with activated user management).

With activated user management:

- 2 Login

Enter user name and password or register as a guest (see Section 4.16.4).

Then the photometer displays the *Self test* dialog.

- 3 Remove all cells and close the cell shaft cover.

- 4 Start the self-test with **<START-ENTER>**.

The photometer carries out the self-test.

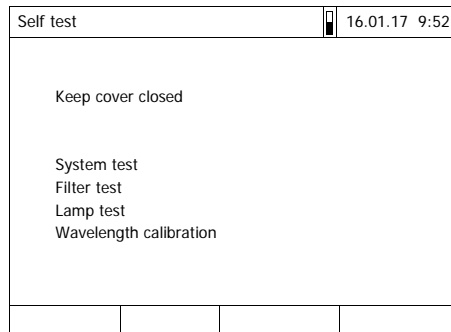

The self-test includes:

- the test of memory, processor, internal interfaces, filter and lamp
- a calibration for each wavelength

After the self-test is completed, the main menu is displayed.



The result of the self-test can be viewed and printed with the *[Info]* function key (see Section 4.18).

**Automatic wavelength calibration**

With the automatic wavelength calibration, the photometer checks and calibrates the accuracy of the wavelengths created (by the monochromator).

The wavelength calibration of the photometer takes place regularly after the photometer was switched on (within the framework of the self-test) and is automatically repeated during operation after 15, 30, 60, 120 and 240 minutes.

While the automatic wavelength calibration is running on the photometer, a note is displayed. The automatic wavelength calibration only starts if the cell shaft is empty.

If a cell is in the cell shaft the wavelength calibration is carried out only after the cell was removed.

**Switching off**

To switch the photometer off, keep the **<ON/OFF>** key depressed until the photometer is switched off.

## 4.2 General operating principles

### 4.2.1 Navigating with function keys and menus

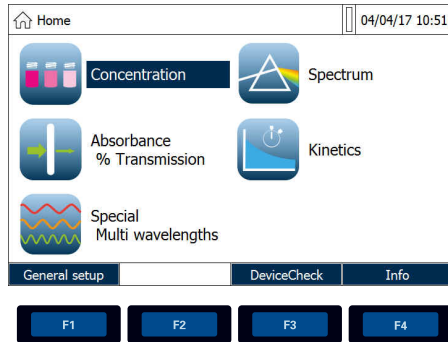

Press the <▲><▼><◀><▶> key.

The menu selection moves in the corresponding direction.

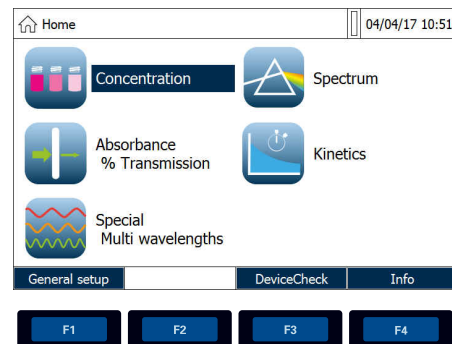

Press the function key <F1> (*[Setup]*). The *General setup* submenu pops up.

<F1>

<START-ENTER>

Press <START-ENTER>. This has confirmed the current selection. A new menu pops up.

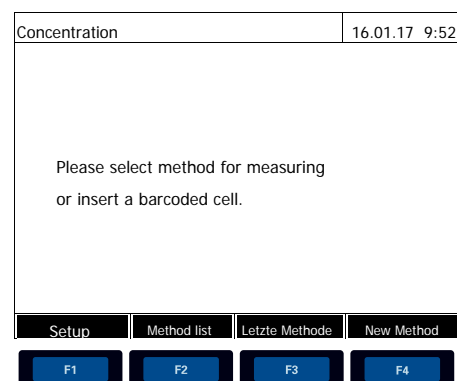
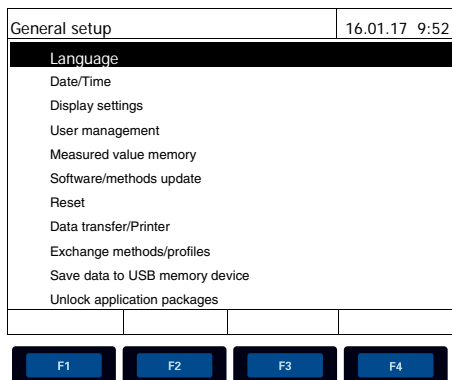

To navigate further, use <▲><▼><◀><▶> and <START-ENTER>

Further navigation with function keys (here: F1 and F2)

The current menu selection is displayed in reverse video. The assignment of the function key menu is adapted to the current operating situation. The functions of the function key menu are started with the function keys (F1 ... F4).

#### Use of the function keys

The function keys F1 to F4 are below the display. Their functions change depending on the operating situation and mode. The current functions are

displayed in the function key menu at the bottom edge of the display.

Apart from navigation, the function keys are also used for other operations:

- Opening a selection list or input field
- Executing a command (directly or with intermediate query)
- Changing the citation form
- Switching between two display options,  
e. g. Absorbance ↔ Transmission

**Navigation with  
arrow keys  
(<▲><▼><◀><▶>  
and  
<START-ENTER>**

These operating elements are used to select an item from a menu or list. The current selection is displayed in reverse video. By pressing **<START-ENTER>** you confirm the selection.

Apart from navigation, the **<START-ENTER>** key is also used for other operations:

- Opening a selection list or input field
- Confirming a selection
- Confirming entries of text and numerals
- Executing a command (directly or with intermediate query)
- Activating an item in a selection list (✓ = active)

#### 4.2.2 Display of navigation paths in short form

In this operating manual, the introductory navigation steps leading to individual menus or dialogs are clearly shown in a gray box. The box indicates a section of the menu tree.

Starting point of the description is always the main menu, which can be reached with the **<HOME>** key from any operating situation. From there navigation takes place downward.

**Operating example:  
Navigation to the  
setting menu for the  
language**

The following example shows the elements of the menu tree with the relevant operating steps:

**<HOME>**  
 [General setup]  
 |— Language

In this operating manual, bold letters and angle brackets indicate a key on the photometer (except function keys).

- ∅ Press the "Home" key.  
The main menu is called up.

Square brackets in this operating manual indicate a function key F1 to F4. The text between the brackets corresponds to the assignment according to the function key menu on the bottom edge of the display.

- ∅ Press the function key with the assignment "Settings"

Text without brackets stands for a menu item indicated on the display (list item) in this operating manual.

- ∅ Select the menu item with the arrow keys **<▲>****<▼>**. The current selection is displayed in reverse video.
- ∅ Then press **<START·ENTER>**.

Further navigation options:

- With the **<ESC>** key you move up a level in the menu tree.
- The **<HOME>** key directly calls up the main menu.



If you are "lost" in a menu, press **<HOME>** and restart navigating from the main menu.

### 4.2.3 Entry of numerals, letters and characters

Numerals, letters, punctuation marks and special characters are entered with the alphanumeric keypad of the meter or using an external keyboard that can be connected to the instrument via the USB-A interface.

#### Character set

The following characters are available:

- Numerals 0 ... 9
- Letters A ... Z and a ... z
- Punctuation marks. -
- Special characters ° / + <sup>2</sup> <sup>3</sup> # %

#### Operating principle



Entering characters is always possible if there is an input field on the display.

The numerals and characters (except for the small letters) assigned to the keys of the alphanumeric keypad are printed on the keys. Example: With the **<7/PQRS>** key you can enter the following characters: 7, P, Q, R, S, p, q, r, s.

Select the required character by pressing the key several times (similar to a mobile phone). When pressing a key that is assigned to several characters once, the respective numeral appears first. To enter a numeral, one key-pressing is always sufficient.

When pressing the key for the first time a line pops up that displays all characters possible with this key. The currently selected character is highlighted.

A character is taken over in the input field if

- the character is highlighted for more than one second,
- the character is confirmed with **<START-ENTER>**,
- another alphanumeric key is pressed.



During mere number entries (such as entering a wavelength), the keys of the alphanumeric keypad are assigned to the respective numeral only. Each keypressing directly enters the numeral (like a pocket calculator).

#### Special characters

Special characters are entered with the **<1/\*>** key.

#### Operating example: Entering the ID

The *Enter ID* input field appears if you press the **<STORE>** key while the store symbol is visible. In the following example a measurement dataset with the ID "Test" is stored.

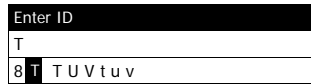
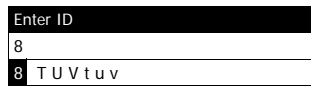

- 1 Press **<8/TUV>** several times until "T" appears in the input line.

Below the input field, a selection line pops up with all characters that are available for this key, e.g. *8 T U V t u v*.

The currently selected character is highlighted.

After approx. one second the character is taken over and the selection line closed.

- 2 Complete the ID with **<A...9>** and confirm.

**Correcting incorrect entries**

Using **<<>**, erase all characters until you have reached the incorrect digit and repeat the entry from there.

**4.2.4 Detailed operating example: Changing the language**

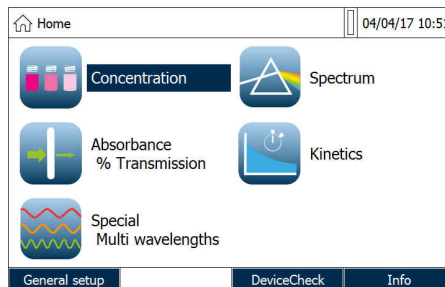

- 1 Call up the main menu with the **<HOME>** key.
- 2 Open the *General setup* menu with the F1 function key [*Setup*].

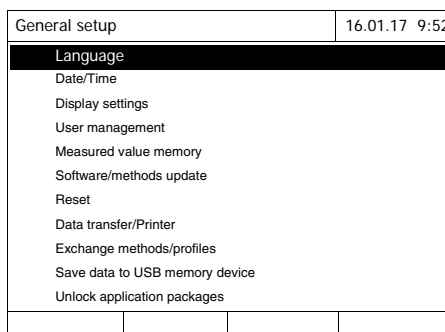

- 3 Using **<▲><▼>**, select the *Language* menu item and open with **<START-ENTER>**.

The *Language* menu shows a list with the available languages. The currently active language has a checkmark.



- 4 Select the required language from the list with **<▲><▼>** and confirm with **<START-ENTER>**.

The selected language is taken over immediately. The photometer moves up one menu level.

### 4.2.5 Inserting a cell

#### 16 mm cell tests (with and without barcode)

Inserting a cell with barcode starts the measurement; with methods without barcode you have to select the method (see Section 4.5.5 SELECTING A METHOD MANUALLY).

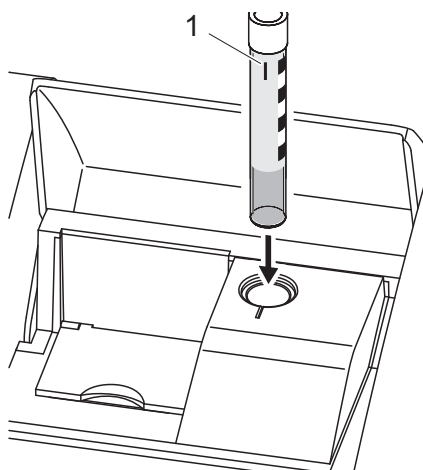

- 1 Open the cell shaft cover.
- 2 Close the inner turn-up lid.
- 3 Insert the barcoded round cell in the round cell shaft so it touches the bottom. Align the line (1) to the front with the notch on the round cell shaft.

The photometer selects the method based on the bar code and automatically starts measuring.

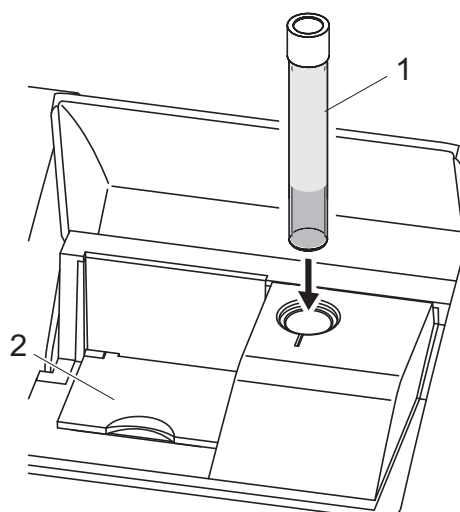

- 1 With cells without barcode: Select the method manually in the instrument.
- 2 Close the inner turn-up lid (2).
- 3 Insert the round cell (1) in the round cell shaft so it touches the bottom.





If the inner turn-up lid is opened too wide, a message prompts you to close the inner turn-up lid.

### Rectangular cells and 24 mm- round cells

There is a customary barcode for each method. By reading this barcode with the external barcode reader, the appropriate method is selected automatically.

There are method barcodes in the method descriptions, on the reagent packaging and on our webpage (for download in order to use these in your own documents). For reagents that can be used for several methods, the barcode on the reagent packaging indicates the most frequently-used method.

User-defined methods and reagent-free methods normally do not have a barcode and therefore, no automatic method recognition. In this case, select the method manually (see Section 4.5.5 SELECTING A METHOD MANUALLY) and then insert the cell.

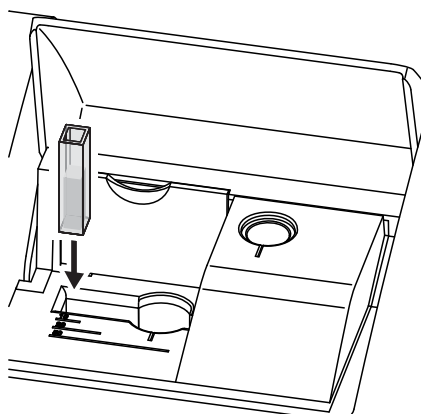
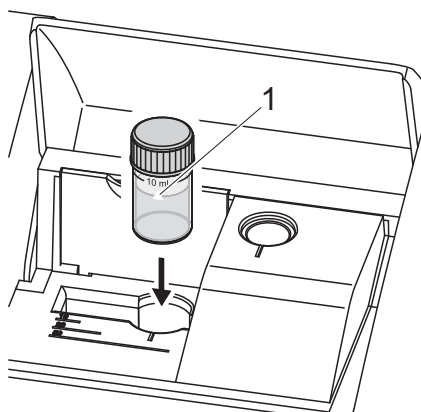

- 1 Open the cell shaft cover.
- 2 Select method by scanning the method barcode with the external barcode reader or select manually on the instrument.
- 3 Open the inner turn-up lid.
- 4 Insert 24 mm cell, aligning the arrow marking (1) to the front with the notch on the round cell shaft.  
or
- 5 Insert the rectangular cell vertically until it touches the bottom and align on the left stop of the cell shaft. The opaque sides of the rectangular cell must point to the front and back.

The correct measuring range is automatically selected when the rectangular cell (1, 2, 5 cm) is inserted.



The photometer has an external light recognition. If there is too much external light, a message prompts you to close the cell shaft cover.

### 4.2.6 Usable cells

Depending on the wavelength range, different kinds of cells are suitable. Suitable are round cells, all rectangular cells of glass, quartz or plastic, whose side surfaces are frosted (see Section 8.1). Cells with clear or serrated lateral surfaces are not reliably recognized by the automatic cell recognition.

Especially with plastic single-use cells we recommend you test them for suitability prior to carrying out large-scale series of measurements.

With the use of less than 10 ml test volumes, 50 mm so-called semi-micro cells must be used.

For measurements in the UV range below 320 nm, glass cells and commercial PS plastic cells are not suitable; below 280 nm, commercial PMMA plastic cells are not suitable due to their transmission characteristics. Therefore, use quartz cells or tested single-use cells (plastic) for applications in the UV range.



Details on the minimum filling level and minimum filling volume are given in Chapter 7 TECHNICAL DATA.

## 4.3 Photometer settings and system administration

The general photometer settings are made on the **<HOME>** *General setup* -> menu. These comprise:

- Language (see Section 4.3.1)
- Date/time (see Section 4.3.2 and Section 4.2.4)
- Display characteristics (see Section 4.3.3)
- User management (see Section 4.16)
- Administration of the measurement data memory (see Section 4.11)
- Software and method update (see Section 4.20)
- Reset of the settings to default values (see Section 4.17)
- Settings for data transmission (see Section 4.14.2)

### 4.3.1 Language

The complete list of the available instrument languages is given in the *Language* chapter and in Chapter 7 TECHNICAL DATA menu of the photometer.



How to set the language is described in detail in the operating example in Section 4.2.4.

### 4.3.2 Date/Time

The date format is set automatically with the language setting. According to the locally usual version, the date format is displayed in the order, Day.Month.Year (*DD.MM.YY*) or Month/Day/Year (*MM/DD/YY* or *MM.DD.YY*).



The *Date/Time* menu opens.

**1** Select and confirm *Date*.

The input field for the current date pops up.

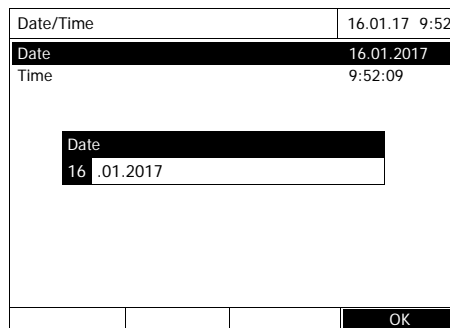

**2** Enter the current date with **<0...9>** and confirm.

The input field closes.  
The date is accepted.

**3** Select and confirm *Time*.

The input field for the current time pops up.

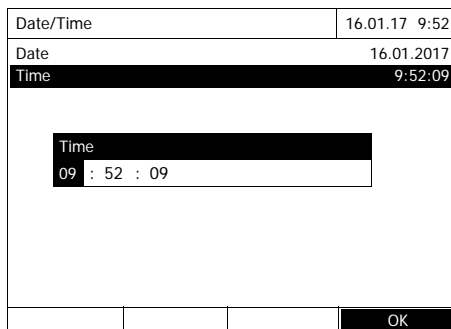

4 Enter the current time with **<0...9>** and confirm.

The input field closes.  
The time is accepted.

### 4.3.3 Display settings

Here you can adjust the display brightness to the lighting conditions.

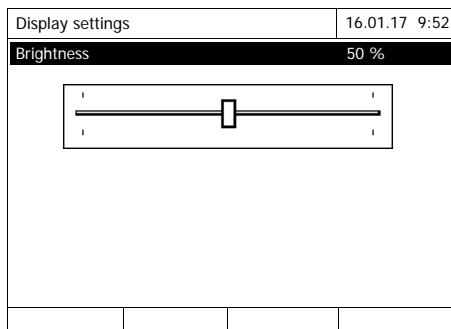
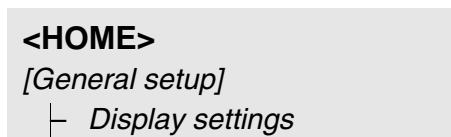

1 Select and confirm *Brightness*.

A slide control for the display brightness appears.

2 Set and confirm the display brightness with **<◀>▶>**.

## 4.4 Zero adjustment

A valid zero adjustment is required for the calculation of measured values in the modes, *Concentration*, *Absorbance / % Transmission*, *Special / Multi wavelengths* and *Kinetics*. With a zero adjustment, the absorbance of a cell filled with distilled water ("zero cell") is measured and stored as the zero value.

### Factory zero adjustment for concentration measurements

For all (*Concentrationmode*) there is a factory zero adjustment already when the instrument is delivered. We recommend replacing it with a zero adjustment of your own. If a zero adjustment exists already for a method, the date and time of the last zero adjustment are displayed in the top right area of the display.

### Zero adjustment for absorbance measurements

In the *Absorbance* mode, the zero adjustment has to be carried out separately for each cell type and each wavelength used. If a zero adjustment exists already for the inserted cell type at the selected wavelength, the date and time of the last zero adjustment are displayed in the top right area of the display.

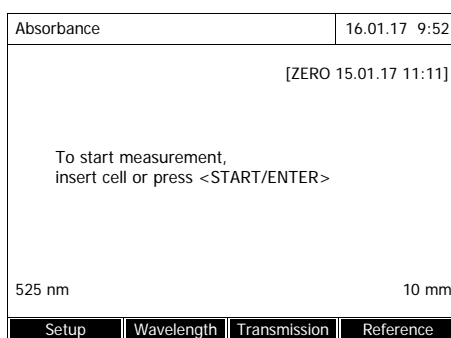

If no zero adjustment is available, the photometer will prompt you to carry out a zero adjustment.



The cells must be absolutely clean and free of scratches. Always use a cell of the same type for zero adjustment and measurement of the sample.

### Notes on zero adjustment

Zero adjustment with round cells:

- Only use clean, scratch-free round cells with distilled water. The minimum filling level is 20 mm. Two filled zero cells (Ø 16 mm and Ø 24mm) are included in the scope of delivery of the instrument and the verification standard kit (see Chapter 8 ACCESSORIES AND OPTIONS).
- A zero cell can, in principle, be used any number of times. Regularly check the zero cell for visible contamination and scratches. If necessary, replace them (recommended: every 24 months).

Zero adjustment with rectangular cells:

- For rectangular cells, the zero adjustment must be carried out with the same cell type (manufacturer and glass type [e.g. optical glass, quartz glass, plastic]) that is used for measurement. This is important because cells of different manufacturers have different absorption behavior. When changing the cell type repeat the zero adjustment with the new type.
- Prior to zero adjustment, clean the rectangular cell and fill it with distilled water. The minimum filling level is 20 mm.
- Rectangular cells always have to be inserted in the cell shaft with the same orientation for measurement and zero adjustment (e.g. cell printing on the left side).



Information on cells is provided in Chapter 7 TECHNICAL DATA. Note that the spectral transparency of the cell must be suitable for the intended application (example, quartz cell for UV range).

**Carrying out a zero adjustment**

The zero adjustment is done similarly in the *Concentration, Absorbance / % Transmission, Special / Multi wavelengths* and *Kinetics* modes.

- 1 In the respective mode, press the **<ZERO-BLANK>** key.
- 2 In *Concentration* mode only: Select and confirm *Zero adjustment*.

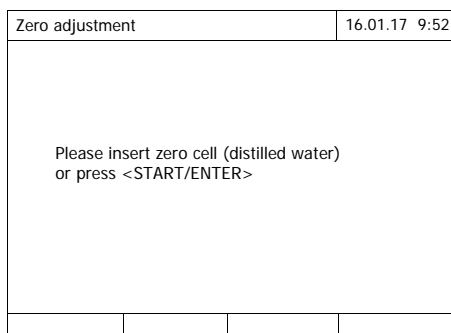
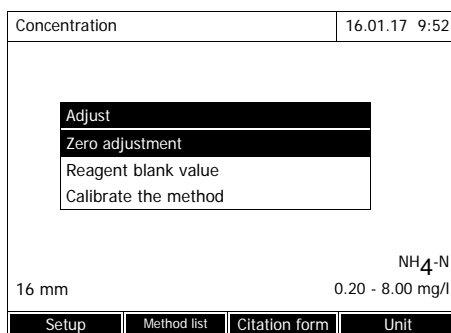

The zero adjustment window pops up.

- 3 Insert the zero cell (see Section 4.2.5 INSERTING A CELL).

The photometer automatically starts the zero adjustment and subsequently stores the value.

- 4 After a successful zero adjustment, switch to measurement with [OK].

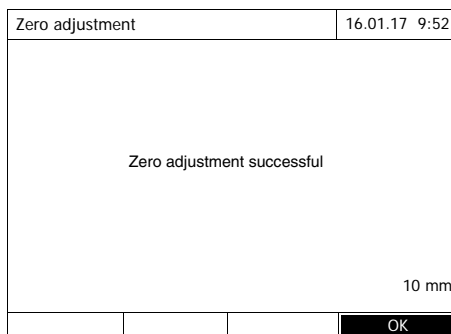

**Validity of the zero adjustment**

The data of the zero adjustment is stored in the photometer separately for each cell type. As long as the data is valid, it is automatically used again after a temporary change to a different cell type. The validity depends on the respective mode:

<b>Mode</b>	<b>Validity of the zero adjustment</b>
<i>Absorbance / % Transmission</i>	<ul style="list-style-type: none"> <li>● Till the next zero adjustment with the same wavelength *</li> </ul>
<i>Concentration (user-defined methods) and Special / Multi wavelengths</i>	<ul style="list-style-type: none"> <li>● Till the next zero adjustment for the same method *</li> </ul>
<i>Kinetics</i>	<ul style="list-style-type: none"> <li>● Till another kinetic profile is loaded</li> <li>● Till the <i>Kinetics</i> mode is exited or the photometer is switched off</li> </ul>

\* The photometer displays that a zero adjustment is available and the time it was carried out. You can then decide whether to use this zero adjustment or carry out a new zero adjustment.

**When to repeat the zero adjustment?**

We recommend to repeat the zero adjustment in the following cases:

- If the photometer was subject to mechanical stress such as strong shock or transport
- If the ambient temperature changed by more than 5 °C since the last zero adjustment
- After the lamp was replaced
- At least once per week
- With use of a new cell type (different manufacturer, different glass type)
- Basically each time you want to measure with the highest possible accuracy.

## 4.5 Measuring in *Concentration* mode

### 4.5.1 Measuring cell tests with barcode

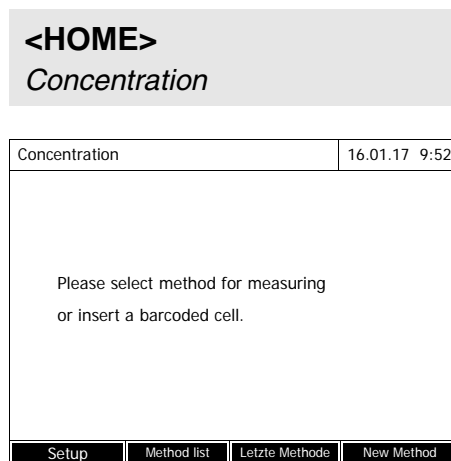

Inserting a cell with barcode starts a measurement.

- 5 Insert the barcoded round cell in the round cell shaft so it touches the bottom. When doing so, align the line mark with the notch at the front of the round cell shaft (see Section 4.2.5 INSERTING A CELL).

The photometer selects the method based on the bar code and automatically starts measuring.

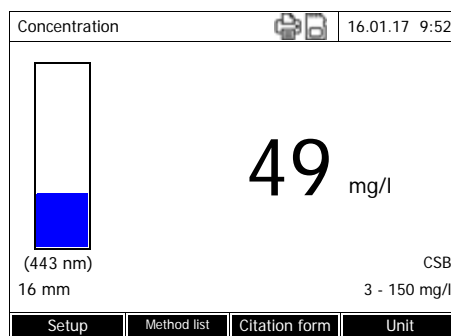

- 6 Other options:

- Select another citation form with *[Citation form]* (e. g.  $\text{NH}_4 \leftrightarrow \text{NH}_4\text{-N}$ ).
- Select another measurement unit with *[Unit]* (e. g.  $\text{mg/l} \leftrightarrow \text{mmol/l}$ ).
- With multi-stage methods, partial results can also be called up here
- Make further settings with *[Setup]* (see Section 4.5.6).



### 4.5.2 Measuring reagent tests, external barcode reader

For each method that can be measured with a reagent test, there is a customary barcode. This is in the header line of the method description. In addition, it can also be downloaded from our website so that you can use it in your own documents (e.g. a SOP).

Furthermore, on most reagent packagings, there is a barcode that indicates the associated method. For reagents that can be used for several methods, in this case the barcode indicates the most frequently-used method.

By scanning this barcode with the external barcode reader, the corresponding method is selected (see also Section 3.4.5).

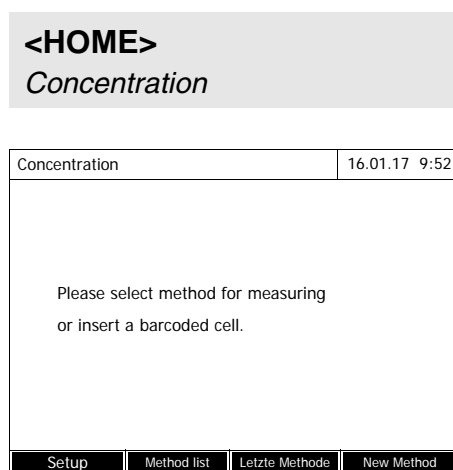

**1** Open the cell shaft cover.

**2** Scan barcode with the external barcode reader. The photometer selects the correct method with the aid of the barcode.

**3** Insert 24 mm round cell or rectangular cell (see Section 4.2.5 INSERTING A CELL). The correct measuring range is automatically selected when the rectangular cell (1, 2, 5 cm) is inserted.

The photometer starts measuring automatically.

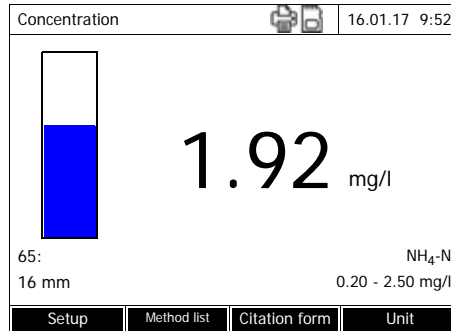

4 Other options:

- Select another citation form with [Citation form] (e. g. NH<sub>4</sub> ↔ NH<sub>4</sub>-N).
- Select another measurement unit with [Unit] (e. g. mg/l ↔ mmol/l).
- With multi-stage methods, partial results can also be called up here
- Make further settings with [Setup] (see Section 4.5.6).

4.5.3 Measuring user-defined methods

User-defined methods have no barcode and therefore also no automatic method detection. In such a case, select the method manually:

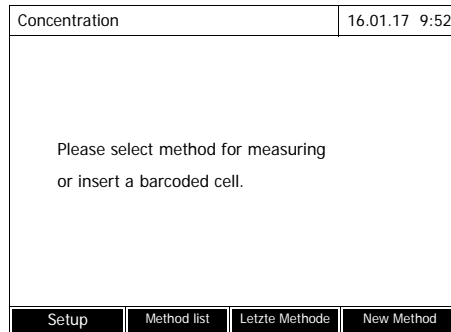
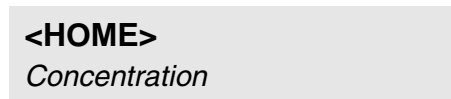

1 Selecting a method manually (see Section 4.5.5).

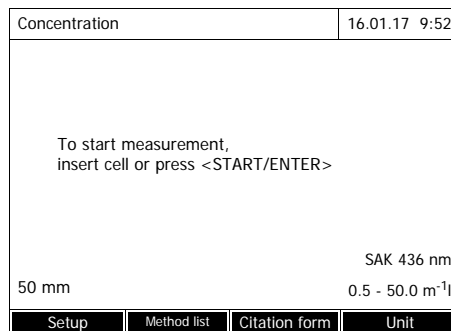

The photometer is ready for measurement.

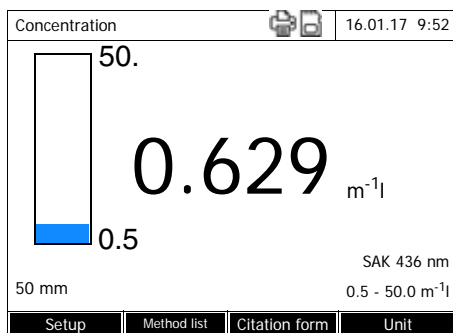

**2** Insert cell (round cell or rectangular cell)(see Section 4.2.5 INSERTING A CELL).

**3** Other options:

- Select another citation form with *[Citation form]* (e. g.  $\text{NH}_4 \leftrightarrow \text{NH}_4\text{-N}$ ).
- Select another measurement unit with *[Unit]* (e. g.  $\text{mg/l} \leftrightarrow \text{mmol/l}$ ).
- With multi-stage methods, partial results can also be called up here
- Make further settings with *[Setup]* (see Section 4.5.6).

#### 4.5.4 Exceeding the upper or lower limits of the measuring range

Measured values outside the limits of the measuring range are displayed in red.

Measured value display if the measured value is outside the measuring range:

Range	Display	Example: MR: 10 - 150 mg/l
LL < MV < UL	Measured value	<b>128</b> mg/l
<b>1</b> UL < MV < UL + 10%	Upper limit of measuring range exceeded by up to 10% and measured value	<b>&gt; 150</b> <b>157</b> mg/l
	LL - 50% < MV < UL	<b>&lt; 10</b> <b>7</b> mg/l
<b>2</b> MV > UL + 10%	Upper limit of measuring range exceeded by more than 10%	<b>&gt; 150</b> mg/l
	MV < LL - 50%	<b>&lt; 10</b>

Range	Display	Example: MR: 10 - 150 mg/l
3 Invalid measured value e.g. <b>MV</b> < 0	Lines	 mg/l

MR = Measuring range

UL = Upper limit value of the measuring range

LL = Lower limit value of the measuring range

MV = Measured value

### 4.5.5 Selecting a method manually

#### Select last method used

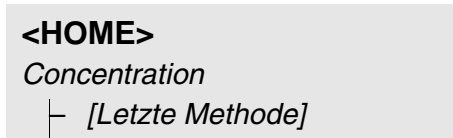

The last method used is selected immediately.

#### Select method from Method list

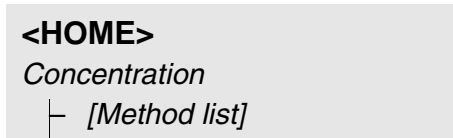

The list of methods is displayed. The methods are sorted by method number. The arrows ▼ or ▲ on the right edge indicate that the list comprises more methods further up or down.

The last method selected is marked.

#### Select method:

- 1 Use <▲><▼> to select the desired method. The current selection is displayed in reverse video.
- 2 Use <START-ENTER> to take over the selection.

**Restricting the method list**

This is how you can restrict the method list and make searching easier:

- With *[Last used]* you can restrict the method list to the ten last methods used.
- With the search function you can search certain character strings in the list. The search takes place as a full-text search of the entire list contents. Thus you can search for a method number, test name or certain citation form.

**Search function**

Select method (last used)		16.01.17 9:52
<input type="text" value="CO_"/>		
130	CSB	3 - 150 mg/l
133	CSB	15 - 300 mg/l
131	CSB	20 - 1500 mg/l
132	CSB	200 - 15000 mg/l
<input type="button" value="All methods"/>		

Search for character string:

Use **<A...9>** to enter the character string you want to search for in the search window.

The list below displays all hits that include the character string. With each character input, the hit list is updated.



When searching, pay attention to the correct upper and lower case. The input of subscripted characters is not required or possible. They are treated as normal characters.

**4.5.6 Settings for Concentration mode**

Prior to measuring, check the settings for the selected method.

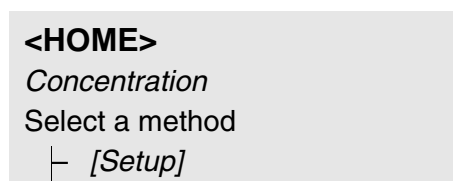

Concentration	16.01.17 9:52
Dilution ? Sample blank value User-defined blank value Turbidity correction Display absorbance DeviceCheck Edit method New method Measurement data memory	
<input type="button" value="All methods"/>	

The menu shows an overview of all settings.

Active settings are marked by a tick.

**Overview of the settings**

<b>Menu item</b>	<b>Explanation</b>
<i>Dilution</i>	In the measured value display, the dilution of a sample is indicated in the form [1 + x] (parts sample + parts distilled water). For further instructions, see Section 4.5.7.
<i>Sample blank value</i>	In the measured value display, measurements with sample blank value are marked by [SB] (Sample blank). For further instructions, see Section 4.5.8.
<i>User-defined blank value</i>	If available, a user-defined reagent blank value is used. In the measured value display, measurements with a user-defined reagent blank value are marked by [BV/Lot number]. For further instructions, see Section 4.5.9.
<i>Turbidity correction</i>	Activates/deactivates the automatic turbidity correction. In the measured value display, measurements with automatic turbidity correction are marked by [TURB]. For further instructions, see Section 4.5.11.
<i>Display absorbance</i>	Activates/deactivates the display of the absorbance value in addition to the main measured value.
<i>DeviceCheck</i>	View the settings for the instrument checking and change them without discarding the current measurement.
<i>Edit method</i>	Edit user-defined methods.
<i>New method</i>	Create user-defined methods.
<i>Measurement data memory</i>	View the measurement data memory.

#### 4.5.7 Measuring diluted samples

If the concentration of a sample exceeds the measuring range of a method, you can dilute the sample so that the concentration of the diluted sample is

in the measuring range of the method. Thus, a valid measurement is possible.

After input of the factor for the dilution, the instrument takes over the conversion to the concentration of the undiluted sample.



Optimum measurement results are achieved if the concentration of the diluted sample is in the middle of the measuring range of the method after diluting.

**Adjusting dilution**

**<HOME>**  
Concentration

Concentration	16.01.17 9:52				
Please select method for measuring or insert a barcoded cell.					
<table border="1"> <tr> <td>Setup</td> <td>Method list</td> <td>Letzte Methode</td> <td>New Method</td> </tr> </table>		Setup	Method list	Letzte Methode	New Method
Setup	Method list	Letzte Methode	New Method		

Inserting a cell with barcode starts a measurement.

If a cell without barcode is used:  
Selecting a method manually  
(see Section 4.5.5).

Concentration	16.01.17 9:52				
To start measurement, insert cell or press <START/ENTER>					
NH <sub>4</sub> -N					
16 mm	0.20 - 8.00 mg/l				
<table border="1"> <tr> <td>Setup</td> <td>Method list</td> <td>Citation form</td> <td>Unit</td> </tr> </table>		Setup	Method list	Citation form	Unit
Setup	Method list	Citation form	Unit		

The photometer is ready for measurement.

Concentration	16.01.17 9:52				
<table border="1"> <tr> <td>Sample + distilled water</td> </tr> <tr> <td>1 + _</td> </tr> </table>		Sample + distilled water	1 + _		
Sample + distilled water					
1 + _					
NH <sub>4</sub> -N					
16 mm	0.20 - 8.00 mg/l				
<table border="1"> <tr> <td>Setup</td> <td>Method list</td> <td>Citation form</td> <td>Unit</td> </tr> </table>		Setup	Method list	Citation form	Unit
Setup	Method list	Citation form	Unit		

- 1 Open the settings menu with [Setup].
  - 2 Select and confirm *Dilution*.
  - 3 Enter the dilution (<0...9>) and confirm.
- The dilution entered will be considered for the next measurement.

The entered value for the dilution factor is valid for the selected method only. The dilution factor is erased if

- the instrument is switched off
- another method is selected
- the factor 0 is input on the *Dilution* menu.

If a dilution factor is active, it is indicated during measurement on the display in the form [1 + x].

#### 4.5.8 Sample blank value

By measuring and using a sample blank value, measurement errors due to coloring and turbidity of the sample matrix can be eliminated to a large extent.

The sample blank value is a property (coloring) of the current sample to be examined. It is determined by measuring the blank sample.

The sample blank value is determined with the same procedure as the corresponding analysis but without the coloring reagent. The sample blank values required are explained in detail in the relevant analysis specification.

#### Validity

The sample blank value applies to the next measurement only. It has to be redetermined prior o each measurement.

#### Single and multiple determination

The sample blank value can be determined by single or multiple determination. With multiple determination, the sample blank value is calculated as the median from the individual measured values.

#### Measuring the sample blank value

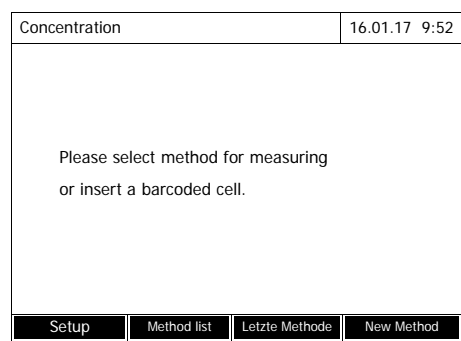
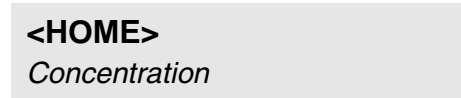

Inserting a cell with barcode starts a measurement.

If a cell without barcode is used: Selecting a method manually (see Section 4.5.5).



Concentration	16.01.17 9:52
To start measurement, insert cell or press <START/ENTER>	
16 mm	NH <sub>4</sub> -N 0.02 - 2.50 mg/l
Setup	Method list   Citation form   Unit

The photometer is ready for measurement.

- 1 Open the settings menu with [Setup].
- 2 Select and confirm *Sample blank value*.

Sample blank value	16.01.17 9:52
To start measurement, insert cell or press <START/ENTER>	
16 mm	NH <sub>4</sub> -N 0.02 - 2.50 mg/l

- 3 Insert the cell with a suitable blank sample.

The first single measurement for the sample blank value takes place.

The following data is displayed as the result:

- The measured absorbance from the (last) single measurement.
- The median from all single measurements carried out up to now.

Sample blank value	16.01.17 9:52
Last measured absorbance 0.115 Median 0.115 (1 Measurement(s))	
16 mm	NH <sub>4</sub> -N 0.02 - 2.50 mg/l
Next meas.	Discard   Apply

- 4 If necessary, make additional single measurements for the median value formation with [Next meas.] or discard the last single measurement with [Discard].
- 5 To accept the median value, press [Apply].

Concentration	16.01.17 9:52
[SB]	
To start measurement, insert cell or press <START/ENTER>	
16 mm	NH <sub>4</sub> -N 0.02 - 2.50 mg/l
Setup	Method list   Citation form   Unit

The photometer is ready for measurement.

The use of the sample blank value is indicated by [SB] in the top right corner of the display.

### 4.5.9 Reagent blank value

The evaluation of the photometric measurement always refers to the comparison value of a test sample without the substance to be determined (reagent blank value). Thus the influence of the basic absorbance of the reagents on photometric measurement, e.g. the inherent coloring, is taken into account.

In practice, the reagent blank value is measured with the same amount of deionized water instead of sample.

#### Factory-set and individual reagent blank values

With photometric concentration determination, the reagent blank value is a constant. The method data for all pre-programmed methods (*Concentration mode*) includes a precisely determined reagent blank value. This value is overwritten if you measure the reagent blank value yourself (setting, *User-defined blank value*, see Section 4.5.6).



You can increase accuracy if you determine the reagent blank value with a test of a new lot and use the reagent blank value for all further measurements with this lot. This is especially recommended for measurements in the vicinity of the lower limit of the measuring range. To be able to attribute the reagent blank value in the measured value documentation later, you can enter the lot number of the reagent package (*Lot number*) during the blank value determination.

#### Validity

The factory blank values always remain stored in the meter and can be activated at any time. The reagent blank values you measured yourself also remain stored in the meter until they are overwritten by a new blank value measurement.

#### Single and multiple determination

The reagent blank value can be determined with single or multiple determination. With multiple determination, the reagent blank value is calculated as the median from the individual measured values.

#### User-defined methods

For user-defined methods, you can activate the reagent blank value function as follows only:

Entry type	Function type	Reagent blank value possible?
Enter a function (with and without input of the ordinate section)	Linear	Yes
	Nonlinear	No

Entry type	Function type	Reagent blank value possible?
Input of value pairs or measurement of standard solutions (with input/measurement of E0)	Linear	Yes
	Parabola (2nd order function)	Yes
	Polygon line	No
Input of value pairs or measurement of standard solutions (without input/measurement of E0)	Linear	Yes
	Parabola (2nd order function)	No
	Polygon line	
	Polygon line through zero	



If no value for E0 is stored during the entry of value pairs or the measurement and storing of standard solutions for a nonlinear function (parabola or polygon line), the message, *No blank value correction is intended for this method.* appears when the *User-defined blank value* function is activated. The blank value (E0) can be entered later by editing the method.

### Measuring the reagent blank value

**<HOME>**  
Concentration

Concentration	16.01.17 9:52
Please select method for measuring or insert a barcoded cell.	
Setup	Method list
Letzte Methode	New Method

Inserting a cell with barcode starts a measurement.

If a cell without barcode is used: Selecting a method manually (see Section 4.5.5).

Concentration	16.01.17 9:52
To start measurement, insert cell or press <START/ENTER>	
16 mm	NH <sub>4</sub> -N 0.02 - 2.50 mg/l
Setup	Method list   Citation form   Unit

The photometer is ready for measurement.

Concentration	16.01.17 9:52				
<table border="1"> <tr><td>Adjust</td></tr> <tr><td>Zero adjustment</td></tr> <tr><td>Reagent blank value</td></tr> <tr><td>Calibrate the method</td></tr> </table>		Adjust	Zero adjustment	Reagent blank value	Calibrate the method
Adjust					
Zero adjustment					
Reagent blank value					
Calibrate the method					
16 mm	NH <sub>4</sub> -N 0.02 - 2.50 mg/l				
Setup	Method list   Citation form   Unit				

1 Use **<ZERO-BLANK>** to open the *Adjust* selection list.

or

Open the settings menu with *[Setup]*.

2 Select and confirm *Reagent blank*.

The window for the measurement of the reagent blank value pops up. The data of the last measurement appears in the measured value display.

Reagent blank value	16.01.17 9:52
To start measurement, insert cell or press <START/ENTER>	
16 mm	NH <sub>4</sub> -N 0.02 - 2.50 mg/l

3 Insert the cell with the blank sample.

The first single measurement for the reagent blank value takes place.

The following data is displayed as the result:

- The measured absorbance from the (last) single measurement.
- The median from all single measurements carried out up to now.

Reagent blank value	16.01.17 9:52
Last measured absorbance 0.600 Median 0.600 (1 Measurement(s))	
16 mm	NH <sub>4</sub> -N 0.02 - 2.50 mg/l
Next meas.	Discard
	Apply

**4** If necessary, make additional single measurements for the median value formation with *[Next meas.]* or discard the last single measurement with *[Discard]*.

**5** To accept the median value, press *[Apply]*.

The *Lot number* entry field pops up.

**6** Enter and confirm the *Lot number* (<A...9>).

The blank value measurement is completed.

The photometer is ready for measurement.

The use of the reagent blank value is indicated by [BV/Lot number] in the top right corner of the display.

Reagent blank value	16.01.17 9:52
[BV/Lot number]	
To start measurement, insert cell or press <START/ENTER>	
16 mm	NH <sub>4</sub> -N 0.02 - 2.50 mg/l
Setup	Method list
Citation form	Unit

#### 4.5.10 User calibration (standard adjustment)

With some methods for concentration measurement, there is the possibility to optimize with a user calibration the original calibration stored with the method.

This makes sense, for example, if the original calibration of the method has changed due to the lot.

When creating a user-defined method, you can also allow a user calibration (see Section 4.5.12).

A user calibration is only valid if it deviates from the original calibration by at least 30%.

The absorbance for a user calibration can be measured as a single measurement or multiple measurement. With multiple measurement, the absorbance is calculated as the median from the individual measured values.

If a method is called up for which a user calibration is possible, a query appears asking whether the user calibration should be utilized. If a method is called up for which a user calibration is required, the user calibration has to be carried out before the first measurement.

The use of the user calibration is documented together with the measured value and displayed in the measurement value view with [Cal].

#### Validity

A user calibration is always stored for the method just called up. A user calibration is only deleted if

- a new user calibration is done
- the original calibration for the measurement is selected
- the user calibration is erased manually
- the photometer is reset to the default condition.

#### Carrying out a user calibration



<HOME>  
Concentration

Concentration	16.01.17 9:52
Please select method for measuring or insert a barcoded cell.	
Setup	Method list
Letzte Methode	New Method

Selecting a method manually (see Section 4.5.5).

If data for zero adjustment, reagent blank value or a user calibration are already existing, the photometer informs you of this. You can accept or discard the existing values.

If no zero adjustment is available, the photometer will prompt you to carry out a zero adjustment.

Concentration	16.01.17 9:52
<div style="border: 1px solid black; padding: 5px; width: fit-content; margin: auto;">                 Adjust                  Zero adjustment                  Reagent blank value                  Calibrate the method             </div>	
Setup	Method list
Citation form	Unit

1 Use **<ZERO-BLANK>** to open the *Adjust* selection list.

or

Open the settings menu with *[Setup]*.

2 Select and confirm *Calibrate the method*.

If data for a user calibration are already existing, the list for all standard solutions includes the calibration data of the last user calibration.

If no data of a user calibration are available, the list to measure the *Absorbance* for all calibration standards required pops up.

Calibrate the method	16.01.17 9:52
	Target value ()
E0	0.00 mg/L
1	mg/l
	Absorbance
Back	Next

3 In the *Target value* column, enter the nominal values of the individual standard solutions.

For E0 (reagent blank value) the nominal value is fixed and cannot be changed. The corresponding absorbance has to be measured.

4 Select an absorbance value and confirm with **<START-ENTER>**.

The measurement window pops up.

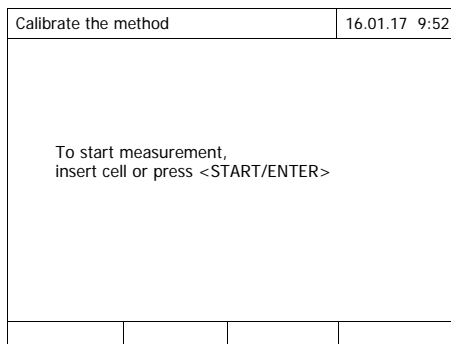

**5** Insert the cell with the corresponding standard or reagent blank value (for E0).

The first single measurement for the calibration is carried out.

The following data is displayed as the result:

- The measured absorbance from the (last) single measurement.
- The median from all single measurements carried out up to now.

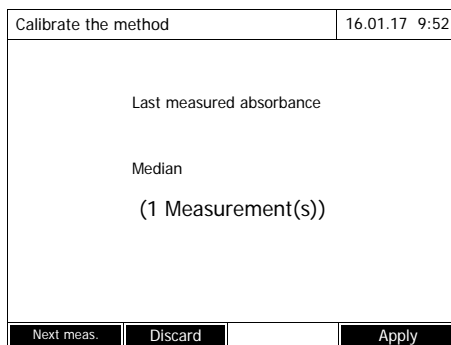

**6** If necessary, make additional single measurements for the median value formation with *[Next meas.]* or discard the last single measurement with *[Discard]*.

**7** To accept the median value, press *[Apply]*.

The list of the standards required for this method pops up. The measured absorbance is entered for the standard or reagent blank value (E0).

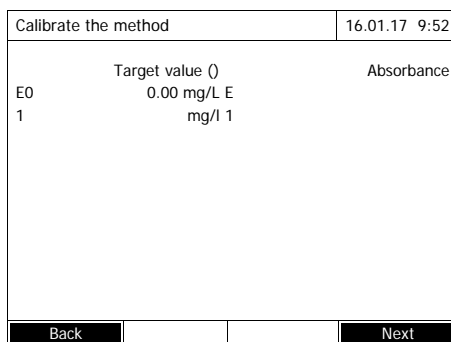

**8** Select all fields consecutively in the column *Absorbance* and start the corresponding measuring procedure with **<START-ENTER>**.

When all values have been measured (including the reagent blank value E0):

**9** Accept the values with *Next*.

The result of the calibration pops up.



Calibrate the method	16.01.17 9:52
The calibration has been successfully completed.	
Protocol ID:	2
Date:	16.01.2012
User:	Admin
Curve type:	Straight line
Correction:	105%
<span>Cancel</span> <span>Calibration</span> <span>Apply</span>	

If necessary, display the list with the value pairs nominal value and absorbance with *Calibration data*.

If necessary, display the calibration line with *Graphic* in the window with the value pairs.

**10** Accept the calibration with *Apply*.

Calibrate the method	 	16.01.17 9:52
User calibration:		
Protocol ID:	2	
Date:	16.01.2012	
User:	Admin	
Curve type:	Straight line	
Correction:	105%	
<span>End</span> <span>Calibration</span> <span>Delete</span> <span>New</span>		

If necessary, display the list with the value pairs nominal value and absorbance with *Calibration data*.



If necessary, display the calibration line with *Graphic* in the window with the value pairs.

If necessary, delete the user calibration with *Delete*.

If necessary, carry out a new user calibration with *New measurement*.

**11** Use *End* to finish calibration.

The *Lot number* input field for input of the *Lot number* of the reagent used pops up.

Calibrate the method	 	16.01.17 9:52
User calibration:		
Protocol	<input type="text" value="Lot number for reagent blank value E0"/>	
Date:	<input type="text" value="-"/>	
User:	Admin	
Curve type:	Straight line	
Correction:	105%	
<span>End</span> <span>Calibration</span> <span>Delete</span> <span>New</span>		

**12** Enter the *Lot number* of the reagent blank value (**<A...9>**) and confirm.

The user calibration is completed.

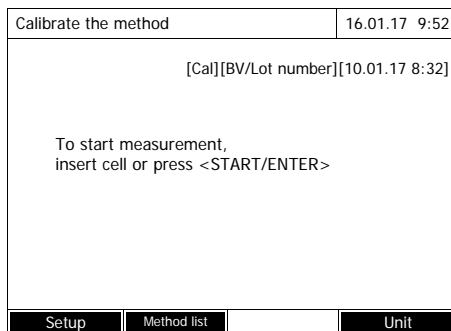

The photometer is ready for measurement.

If the user calibration is utilized, [Cal] appears on the display.

**Note:** calibration is not successful if a new value deviates by more than 30 % from the value of the old calibration.

**Viewing the data of the user calibration**

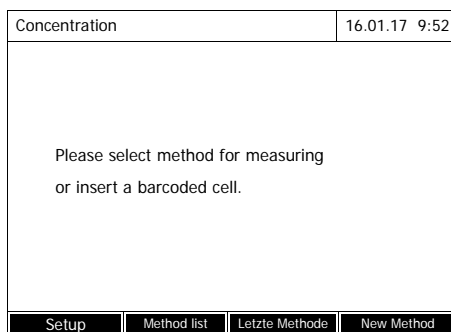
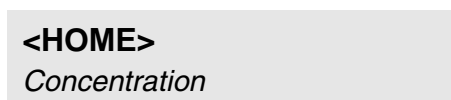

Selecting a method manually (see Section 4.5.5).

If data for zero adjustment, reagent blank value or a user calibration are already existing, the photometer informs you of this. You can accept or discard the existing values.

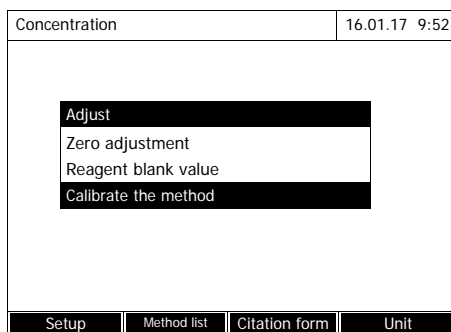

**1** Use **<ZERO-BLANK>** to open the *Adjust* selection list.

or

Open the settings menu with *[Setup]*.

**2** Select and confirm *Calibrate the method*.

The *Calibrate the method* window opens.

The data of the last measurement appears in the window.

Calibrate the method		16.01.17 9:52	
User calibration:			
Protocol ID:	2		
Date:	16.01.2012		
User:	Admin		
Curve type:	Straight line		
Correction:	105%		
End	Calibration	Delete	New

**Measuring with user calibration**

<HOME>  
Concentration

Concentration		16.01.17 9:52									
[Ca][BV/2c][ZERO 10.01.2012 11:08]											
<table border="1"> <tr> <th colspan="2">User calibration</th> </tr> <tr> <td colspan="2">A calibration dated xxx is available for this method. Should it be used?</td> </tr> <tr> <td>Yes</td> <td></td> </tr> <tr> <td>No</td> <td></td> </tr> </table>				User calibration		A calibration dated xxx is available for this method. Should it be used?		Yes		No	
User calibration											
A calibration dated xxx is available for this method. Should it be used?											
Yes											
No											
Setup	Method list	Citation form	Unit								

Selecting a method manually (see Section 4.5.5).

If data for zero adjustment, reagent blank value or a user calibration are already existing, the photometer informs you of this. You can accept or discard the existing values.

If the existing user calibration should not be utilized, a query with further options pops up:

- *Use default calibration*  
The existing user calibration is erased. The following measurements are done with the original calibration that was stored with the method.
- *Carry out user calibration*  
The existing user calibration is erased. The process for a new user calibration is started.
- *Cancel*  
The existing user calibration is retained. The previous query is displayed.

Concentration	16.01.17 9:52		
[Cal][BV/2c][ZERO 10.01.2012 11:08]			
To start measurement, insert cell or press <START/ENTER>			
Setup	Method list	Citation form	Unit

The photometer is ready to measure when all the required data have been confirmed or remeasured.

#### 4.5.11 Automatic Turbidity correction

The *Turbidity correction* function activates the automatic recognition and compensation of the light absorption caused by turbid substances.

After activating the function remains permanently switched on. Measured values that were measured with *Turbidity correction* are labeled with [TURB] (turbidity correction) on the display and in the documentation (printout and memory).

The *Turbidity correction* function is not active in the delivery condition.



The setting for automatic turbidity correction is used with all methods where the automatic turbidity correction makes sense. The photometer automatically decides whether or not to use the function.

With turbidity values that are too high and turbidity correction switched on, the measurement result is marked in red in order to indicate the increased uncertainty of the result.

#### Switching on the turbidity correction

The automatic turbidity correction is activated and deactivated in the setting menu of the concentration measurement (see Section 4.5.6 SETTINGS FOR CONCENTRATION MODE).

#### 4.5.12 Programming / modifying user-defined methods

##### Overview

For *Concentration* mode, you can develop and store your own user-defined methods under the method numbers 1001 to 1100. The photometer software supports you when creating the methods.

##### Calibration data and calibration function

In photometry, the calibration function describes the dependency between the measured parameter (e.g. concentration) and the photometric measurement result (e.g. absorbance) of a sample. The knowledge of this dependency is a prerequisite for the development of a photometric method. The calibration function is usually determined by means of a series of measurements with standard solutions of known concentrations (nominal value), e.g. a 10-point calibration.



In measuring operation, the reverse calibration function is used to output the measured absorbance as a concentration value.

##### Line types

The dependency between the nominal value and absorbance is often linear in a wide range as shown in the following example:

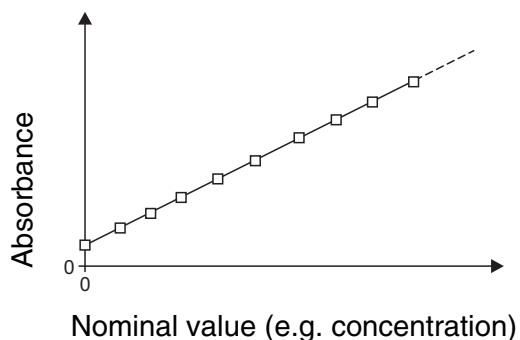

Figure 4-1 Example of a linear calibration function after a 10-point calibration

In the case of a linear dependency, the calibration function is determined by means of linear regression. The slope and axis intercept (E0) are the characteristics of the calibration line.

In the case of a nonlinear dependency, the points of the measuring ranges can be connected to each other as a polygon line or approximated as a parabola:

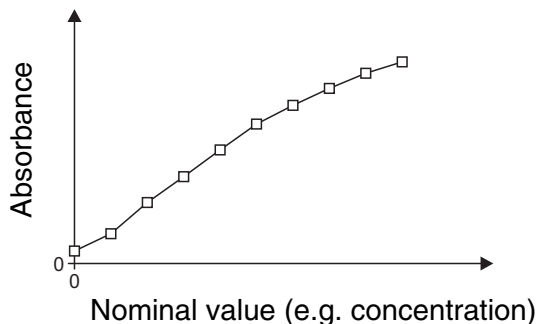

Figure 4-2 Example of a polygon line calibration function after a 10-point calibration

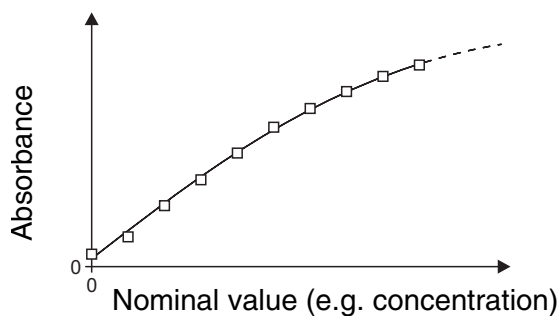

Figure 4-3 Example of a parabola calibration function after a 10-point calibration

## Determining the calibration function

You have the following options to create a method:

- **Measure and store:**

Carry out a series of measurements with the following sample solutions while at the same the photometer takes over the values:

- Blank sample for determination of the reagent blank value (with deionized water instead of sample, see Section 4.5.9)
- at least one, up to ten standard solutions in different concentrations.

The photometer stores nominal value/absorbance value pairs of the individual measurements and determines the resultant characteristics of the calibration. When doing so, you can select the following line types: *Polygon line*, *Straight line* or *Parabola*.

- **Enter as value pairs:**

Entry of the value pairs, Nominal value (concentration) / Measured absorbance of an already available test series with the following sample solutions:

- Blank sample for determination of the reagent blank value (with deionized water instead of sample, see Section 4.5.9)
- at least one, up to ten standard solutions in different concentrations.

Based on the entered value pairs, the photometer determined the characteristics for the calibration. When doing so, you can select the following line types: *Polygon line*, *Straight line* or *Parabola*.

- **Enter a function:**

Entry of a function to calculate the concentration from the absorbance (reverse calibration function). On the photometer, you can enter the coefficients of a polynomial equation of the following type:

$$c = a_0 + a_1 \cdot A + a_2 \cdot A^2 + a_3 \cdot A^3 + a_4 \cdot A^4 + a_5 \cdot A^5$$

with:

c	Measurement result, e.g. concentration
a <sub>0</sub> to a <sub>5</sub>	Coefficients (input range 0.000 to 1000.000)
A	Absorbance



Entering the formula is especially simple if you measure with a commercial test set for which the manufacturer has given the value for the coefficients a<sub>1</sub>. It is often called the "Factor" and corresponds to the reciprocal value of the slope of the straight line of the calibration function.

If a linear function (straight line) should be entered, it is necessary to enter the coefficients a<sub>0</sub> and a<sub>1</sub> to receive correct measured values.

If the exact value for  $a_0$  is not known at the time the formula is entered, it is sufficient to enter the coefficient  $a_1$ . In this case, the *User-defined blank value* function (in the *Concentration / Setup* menu) has to be activated to measure with this method.

Prior to measuring with this method, a blank value measurement has to be carried out. This procedure determines the value for  $a_0$ , which then replaces the value from the programming of the method.

If the *User-defined blank value* function is not activated, the photometer uses the value zero for the coefficient  $a_0$ .

### More information on the entry of the formula (determination of coefficients)

**Linear function** If the value for  $a_1$  (slope of the reverse calibration function) is unknown, you can very simply program the method in the photometer by measuring/storing or entering the value pairs (see above).

For entry as a formula, you can determine the coefficients of the reverse calibration function by linear regression. When doing so, the concentration has to be on the Y axis and the absorbance on the X axis.

In the case of a linear function, the coefficients of the reverse calibration function can also be determined from the reagent blank value determined and the slope ( $m$ ) of the calibration function (Y axis = absorbance, X axis = concentration). Proceed as described below.

Explanation of the coefficients of the formula:

- $a_0 = - E_0 \cdot a_1$   
[ $E_0$  = reagent blank value (absorbance with concentration 0)]
- $a_1 = 1/m$   
Reciprocal of the slope of the calibration function (frequently called the "factor")  
 $m$  = slope of the calibration function
- $a_2, a_3, a_4, a_5$  = additional coefficients (for entry of a linear function: zero)

**Nonlinear function** The coefficients of the reverse calibration function are determined by multiple regression. When doing so, the concentration has to be on the Y axis and the absorbance on the X axis.



Further method data	Input field	Possible entries
	<i>Number</i> *	1001 ... 1100
	<i>Designation</i>	Arbitrary name (max. 18 characters)
	<i>Version</i>	Any version designation (max. 18 characters)
	<i>Wavelength</i> *	Freely selectable (in nm)
	<i>Cell</i> *	13, 16, 24 mm (rund), 10, 20 or 50 mm
	<i>Citation form</i>	e.g. PO4-P (max. 18 characters)
	<i>Unit</i> **	e.g. mg/l (max. 18 characters)
	<i>Resolution</i> *	0.001, 0.01, 0.1 or 1
	Lower and upper limit of the measuring range *	Any value between zero and the highest concentration of the used standard solutions
	Timer 0 to 3	Up to four analysis timers freely adjustable
	<i>MCheck target value</i>	Any value within the measuring range
	<i>MCheck tolerance</i>	Any
	<i>Required measurements</i>	1 or greater Number of measurements after which a measured value is documented. With more than one measurement, the documented value is the median from all measurements.
	<i>Reagent blank value required</i>	Yes/No
	<i>User calibration possible</i>	Yes/No
	<i>User calibration required</i>	Yes/No

\* mandatory inputs

\*\* default value: mg/l



If a nonlinear calibration line is programmed for a method, it may be the case that the default setting of the following menu items cannot be changed:

- *Reagent blank value required*
- *User calibration possible*
- *User calibration required*

## How to program user-defined methods

```

<HOME>
Concentration
├─ [Setup]
└─ New method
  
```

Edit method		16.01.17 9:52
Number	_____	1001
Designation	_____	Nitrite
Version	_____	01
Wavelength	_____	525
Cell	_____	10 mm
Citation form	_____	NO2-N
Unit	_____	mg/l
Resolution	_____	0.001
Calibration curve	_____	Measure standard solutions

Method list   Delete   Next

**1** Enter the general method data here. The next available method number is already entered as number.

You have the following possibilities for filling out the input fields:

- Fill out all blank input fields in sequence
- Use *[Method list]* to select an existing method as template, assign it a new method number and adjust the entries
- Use *[Method list]* to select an existing method for processing (without changing the number).
- Use *[Delete]* to delete the method completely.

**2** Select the menu item, *Calibration curve*. Select the method for the determination of the calibration line. The following variants can be selected:

- *Measure standard solutions*
- *Enter value pairs*
- *Enter formula*

**3** Use *[Next]* to apply all entries on the page and move to the next page.



During the following proceeding, you can return to the previous page at any time with *[Back]*, e. g. if you want to correct entries, add further value pairs or eliminate outliers.

**Variant 1:  
Measure standard  
solutions**

Edit method		16.01.17 9:52	
Standard ID		[REDACTED]	
Standard manufacturer		[REDACTED]	
Back		Next	

- 1 Select and confirm *Measure standard solutions*.
- 2 Enter and confirm details of the standard solutions (optional).
- 3 Use *[Next]* to apply all entries on the page and move to the next page.

The table for the measurement of standard solutions pops up.

Edit method		16.01.17 9:52	
	Target value	Absorbance	
E0	0.000	[REDACTED]	
1	[REDACTED]	[REDACTED]	
Back		Add	Delete Next

In the first two lines of the table, the two value pairs (measuring points) that are at least required for a calibration are already prepared (reagent blank value E0 and any further nominal value).

Edit method		16.01.17 9:52	
	Target value	Absorbance	
E0	0.000	[REDACTED]	
1	0.300	[REDACTED]	
2	0.600	[REDACTED]	
3	1.000	[REDACTED]	
Back		Add	Delete Next

- 4 Create further value pairs with *[Add]* as necessary.
- 5 In the *Target value* column, enter the nominal values of the individual standard solutions.

Measuring the standard solutions:

Edit method		16.01.17 9:52	
	Target value	Absorbance	
E0	0.000	[REDACTED]	
1	0.300	[REDACTED]	
2	0.600	[REDACTED]	
3	1.000	[REDACTED]	
Back		Add	Delete Next

- 6 Using the arrow keys  $\langle \blacktriangle \rangle \langle \blacktriangledown \rangle$  and  $\langle \blacktriangleleft \rangle \langle \blacktriangleright \rangle$ , navigate to the relevant input field in the *Absorbance* column and press  $\langle \text{START} \cdot \text{ENTER} \rangle$ .

Absorbance E0		16.01.17 9:52	
To start measurement, insert cell or press <START/ENTER>			
525 nm		16 mm	

The measurement display is shown.

- 7 Insert the cell with the respective standard.

The absorbance is measured. The result of the first single measurement is displayed.

Absorbance E0		16.01.17 9:52	
Last measured absorbance 0.009 Median 0.009 (1 Measurement(s))			
525 nm		16 mm	
Next meas.	Discard		Apply

- 8 If necessary, make additional single measurements for the median value formation with *[Next meas.]* or discard the last single measurement with *[Discard]*.
- 9 To accept the median value, press *[Apply]*.



If the zero standard concentration (reagent blank value E0) is not measured and stored, the photometer calculates the calibration line without this value. If the function *User-defined blank value* (in the *Concentration / Setup* menu) is activated for measuring with this method, the value for a0 is determined and replaces the calculated axis intercept from the programming of the method (a0 see Page 64).

Edit method		16.01.17 9:52	
	Target value	Absorbance	
E0	0.000	0.009	
1	0.300	0.664	
2	0.600	1.292	
3	1.000	2.178	
Back	Add	Delete	Next

- 10 Repeat the steps 6 to 9 until all input fields in the *Absorbance* column are filled out.
- 11 Use *[Next]* to apply all entries on the page and move to the next page.

The value pairs are displayed in a diagram (standard: Polygon line).

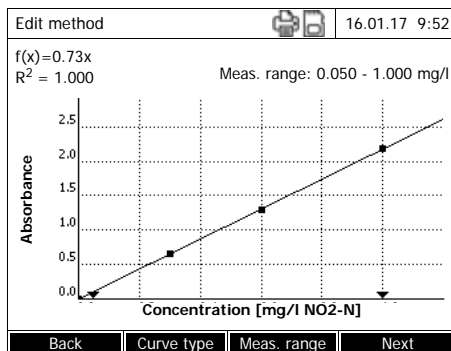

The related formula  $f(x)$  and correlation coefficient  $R^2$  are displayed above the diagram.

**12** If required, select a different line type for the line adjustment with *[Curve type]*.

- Polygon line
- Straight line
- Parabola

**13** If required, enter different measured value limits with *[Meas. range]*.

- Lower limit
- Upper limit

**14** Using *[Next]*, complete the editing of the calibration line and proceed to the next page.

The timers and MCheck data linked to the method are displayed.

Edit method		16.01.17 9:52
Timer 0		00:00:00
Timer 1		00:00:00
Timer 2		00:00:00
Timer 3		00:00:00
MCheck target value		1.00 mg/l
MCheck tolerance		0.10 mg/l
Required measurements		1
Reagent blank value required		No
User calibration possible		No
User calibration required		No
Back		Complete

**15** If necessary, enter intervals for up to 4 timers.

**16** If necessary, enter method check parameter *MCheck target value* and *MCheck tolerance*.

**17** If necessary, set the number from how many single measurements the documented measured value will be calculated.

**18** If necessary, specify whether a reagent blank value is required.

**19** If necessary, set whether a user calibration is possible and/or required.

**20** Complete the programming of the method with *[Complete]*.

The method is programmed and selected for measuring.

**Variant 2:**  
**Enter value**  
**pairs**

Unlike variant 1, the fields of the *Absorbance* column are filled out manually here. Accordingly, you can omit steps 6 to 10. Otherwise, the flow is identical to variant 1.

**Variant 3:**  
**Enter formula**

Edit method	16.01.17 9:52
c = a0 + a1·A + a2·A <sup>2</sup> + a3·A <sup>3</sup> + a4·A <sup>4</sup> + a5·A <sup>5</sup>	
a0	0.605
a1	2
a2	
a3	
a4	
a5	
Lower limit of measuring range	1.000 mg/l
Upper limit of measuring range	3.000 mg/l
Method list	Delete
	Next

- 1 Select and confirm *Enter formula*.  
Input fields for the coefficients (a0 ... a5) of the formula are displayed.
- 2 Enter and confirm the factors.  
If no value is entered for a coefficient the photometer automatically uses the value 0.



Entering the formula is especially simple if you measure with a commercial test set for which the manufacturer has given the value for the coefficients a1. It is often called the "Factor" and corresponds to the reciprocal value of the slope of the straight line of the calibration function.

If a linear function (straight line) should be entered, it is necessary to enter the coefficients a0 and a1 to receive correct measured values. If the exact value for a0 is not known at the time the formula is entered, it is sufficient to enter the coefficient a1. In this case, the *User-defined blank value* function (in the *Concentration / Setup* menu) has to be activated to measure with this method. Prior to measuring with this method, a blank value measurement has to be carried out. During this procedure the value for a0 is determined and replaces the previous value.

- 3 Enter and confirm the measuring range limits.
- 4 Complete the entering of the formula with *[Next]*.  
Timer and method check parameters associated with the method are shown.

Edit method	16.01.17 9:52
Timer 0	00:00:00
Timer 1	00:00:00
Timer 2	00:00:00
Timer 3	00:00:00
MCheck target value	2.000 mg/l
MCheck tolerance	0.200 mg/l
Required measurements	1
Reagent blank value required	No
User calibration possible	No
User calibration required	No
Back	Complete

- 5** If necessary, enter intervals for up to 4 timers.
- 6** If necessary, enter the *MCheck target value* and *MCheck tolerance*.
- 7** If necessary, set the number from how many single measurements the documented measured value will be created.
- 8** If necessary, specify whether a reagent blank value is required.
- 9** If necessary, set whether a user calibration is possible and/or required.
- 10** Complete the programming of the method with [*Complete*].  
The method is programmed and selected for measuring.

## 4.6 Measuring the Absorbance / % Transmission

### 4.6.1 General information

The absorbance or transmission respectively is measured without the use of any methods or profiles. All settings are made in the measurement process.

#### Measuring against the Reference absorbance

The absorbance or transmission can alternatively be measured against the absorbance of the zero adjustment or against a *Reference absorbance* determined by yourself (see Section 4.6.3 MEASURING AGAINST THE REFERENCE ABSORBANCE).

### 4.6.2 Measuring the absorbance or transmission

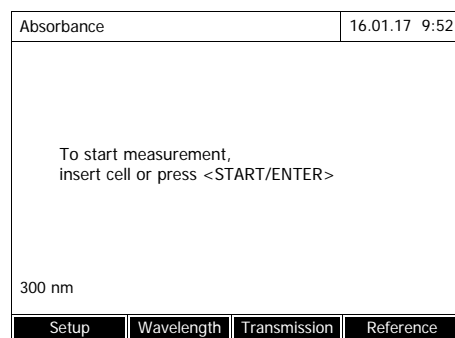
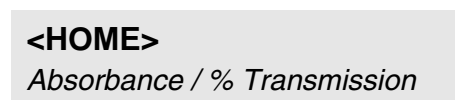

The settings of the last measurement are active.

- 1 Using *[Wavelength]*, change the wavelength as necessary.
- 2 Using *[Absorbance]* <--> *[Transmission]*, you can switch over between absorbance and transmission measurement.
- 3 If necessary, use or measure a reference measurement with *[Reference]* (see Section 4.6.3).
- 4 Insert cell (round cell or rectangular cell)(see Section 4.2.5 INSERTING A CELL).

The photometer starts measuring automatically.



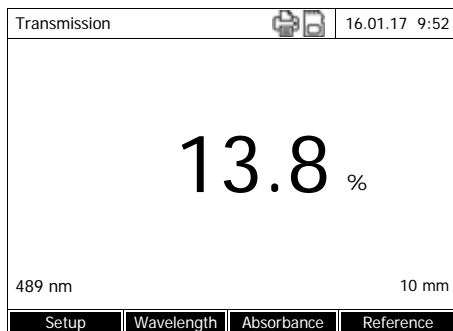

- 5 Using *[Absorbance]* <--> *[Transmission]*, switch over the display from *Absorbance* to *Transmission* or vice versa.

### 4.6.3 Measuring against the Reference absorbance

Each time the photometer is switched on, the absorbance or transmission is measured against the absorbance of the zero adjustment as a basis. You can, however, also determine a *Reference absorbance* and use it as the basis.

The *Reference absorbance* refers to the adjusted wavelength. The measured value remains stored until

- the instrument is switched off
- the cell type is changed
- the wavelength is changed
- a new reference value is measured
- it is deleted manually (*[Reference]* / *Delete*).
- the *Absorbance* / % *Transmission* measuring mode is exited

#### Single and multiple determination

The Reference absorbance can be determined with single or multiple determination. With multiple determination, the mean value is calculated as the median from the individual measured values.

#### Reference absorbance Measuring the

<HOME>  
*Absorbance* / % *Transmission*

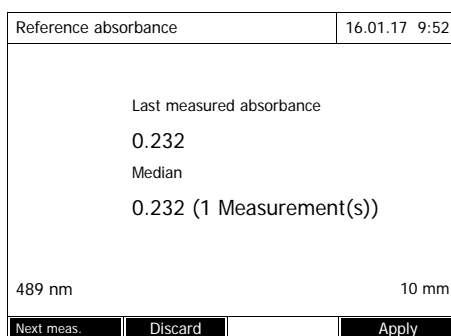
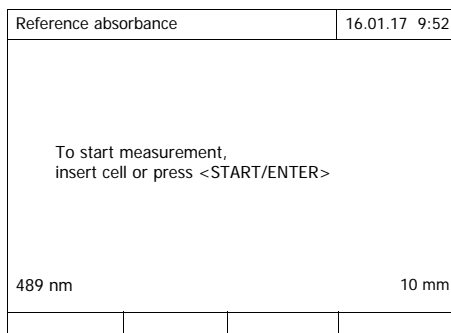
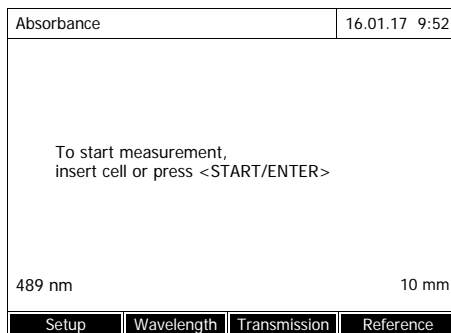

The settings of the last measurement are active.

**1** Start the reference measurement with *[Reference]*.

If a value for the reference absorbance is already stored, it can be deleted or overwritten by a new reference measurement.

After the reference absorbance value has been deleted, the photometer measures against the absorbance of the zero adjustment.

**2** Insert the cell with the reference sample.

The first single measurement for the Reference absorbance is carried out.

The following data is displayed as the result:

- The measured absorbance from the (last) single measurement.
- The median from all single measurements carried out up to now.

**3** If necessary, make additional single measurements for the median value formation with *[Next meas.]* or discard the last single measurement with *[Discard]*.

**4** To accept the median value, press *[Apply]*.

Absorbance	16.01.17 9:52		
Reference::			
To start measurement, insert cell or press <START/ENTER>			
489 nm	10 mm		
Setup	Wavelength	Transmission	Reference

The photometer is ready for measurement.

The reference absorbance is displayed in the top right corner during absorbance or transmission measurement.

## 4.7 Special / Multi wavelengths methods

### 4.7.1 Basic information on Special / Multi wavelengths measurements

In the Special / Multi wavelengths mode of the XD 7000, you can carry out measurements with special methods and functions.

You can use the following functions for these methods:

- Measurements at different wavelengths
- Multiple measurements at one wavelength (e.g. before and after adding a reagent)
- Use of procedure variables.  
Procedure variables provide a value that has to be entered prior to each measurement on the photometer (e.g. volume, pH value or temperature)
- Check whether a value meets a condition.  
With a condition you can check a value for validity (e.g. absorbance value, procedure variable or the result of a formula).
- Formula editor for the convenient programming of any user-defined methods

#### Special methods

The method list in the Special / Multi wavelengths mode comprises:

- preprogrammed multi wavelengths methods
- preprogrammed special methods
- special methods programmed by the user



If you program any special methods yourself, you can use all extended functions of the Special / Multi wavelengths mode.

### 4.7.2 Programming / modifying the Special / Multi wavelengths methods



For multi wavelength methods, you can use the method numbers 2001 to 2499. All special methods can also be selected in the method list of the concentration mode.

The creation of a user-defined method is done in the following steps:

- **Enter the general method data**  
Method number, method name, unit etc.

---

- **Enter the wavelengths for absorbance measurements ( $A_{x \text{ nm}}$ )**  
Minimum 1, maximum 10

---

- **Defining the procedure variables ( $K_x$ ) (optional)**  
Procedure variables are used to take into account any influence quantities that cannot be measured by the photometer.  
The values for these procedure variables have to be entered for all measurements with the method, e.g. the temperature or pH value.

---

- **Enter the formula to calculate the measurement result**  
Enter the formula with which you want to calculate the measurement result in the formula editor.

---

- **Enter an additional condition (optional)**  
Conditions are used to check the measurement result for validity.  
The condition is entered with the formula editor.

**Example:  
Determination of  
Chlorophyll a?  
according to Nusch**

The chlorophyll determination is based on two measurements (before and after adding an acid) of the optical density (= absorbance) of the extract of an aqueous sample at 665 nm.

$$\text{Chlorophyll a } (\mu\text{g/l}) = 29.6 * (A_{(\text{before}) 665 \text{ nm}} - A_{(\text{after}) 665 \text{ nm}}) * (V_{\text{Extract}} / V_{\text{Sample}})$$

*with:*

- |                                      |  |
|--------------------------------------|--|
| $A_{(\text{before}) 665 \text{ nm}}$ | 1. Measurement of the absorbance at 665 nm (before acid addition)    |
| $A_{(\text{after}) 665 \text{ nm}}$  | 2. Measurement of the absorbance at 665 nm (after the acid addition) |
| $V_{\text{Extract}}$                 | Volume of the extract (in ml)  |
| $V_{\text{Sample}}$                  | Volume of the water sample (in ml)                                   |

**Reformulated equation**

For entry on the photometer, assign names that you can enter in the formula editor on the photometer to the variables of the equation.

$$R = 29.6 * (A_{665\text{nm}} - A_{665\text{nm}_2}) * (K_1 / K_2)$$

with:

R (chlorophyll a (µg/l))

$A_{x \text{ nm}}$  (=  $A_{(\text{before}) 665 \text{ nm}}$ )

$A_{x \text{ nm}_2}$  (=  $A_{(\text{after}) 665 \text{ nm}}$ )

$K_1$  (=  $V_{\text{Extract}}$ )

$K_2$  (=  $V_{\text{Sample}}$ )

Numbers

R = result (concentration chlorophyll A in µg/l)

Variables for absorbance.

These values are measured by the photometer. Here: Two measurements with the same wavelength at different times.

With several measurements (e.g. before and after acid addition), the variable names differ through the index appended with an underscore Index  $_y$  (z. B.  $A_{x \text{ nm}}$ ,  $A_{x \text{ nm}_2}$ ,  $A_{x \text{ nm}_3}$ , etc.).

Flow variables

$K_1$  = Volume of the extract (in ml)

$K_2$  = Volume of the water sample (in l)

Freely selectable numeric values

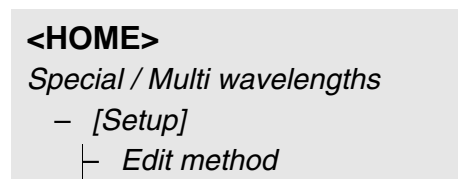

Edit method		16.01.17 9:52
Number		2001
Name	Chlorophyll a	
Version	1.0	
Citation form	Chl a	
Unit	µg/l	
Resolution	0.1	
Cell	10 mm	
Lower limit of measuring	0 µg/l	
Upper limit of measuring	1000 µg/l	
Method list		Delete Next

1 Enter the general method data here. The next available method number is already entered as number.

You have the following possibilities for filling out the input fields:

- Fill out all blank input fields in sequence
- Use *[Method list]* to select an existing method as template, assign it a new method number and adjust the entries
- Use *[Method list]* to select an existing method for processing (without changing the number).
- Use *[Delete]* to delete the method completely.

2 Use *[Next]* to take over all entries and move to the next page.

Wavelength	16.01.17 9:52
Wavelength 1	665 nm
<div style="display: flex; justify-content: space-between; padding: 5px;"> <span>Back</span> <span>Add</span> <span>Delete</span> <span>Next</span> </div>	

Enter wavelengths for the absorbance measurements ( $A_{x \text{ nm}}$ ).

- 3** Use *[Add]* to add an additional wavelength.
- Use *[Delete]* to delete the marked wavelength.
- 4** Use *[Next]* to take over all entries and move to the next page.

Procedure variables	16.01.17 9:52
<p>Procedure variables are variables whose current numerical values have to be entered during the course of the measurement (e.g. weighted sample or dilution).</p> <p>If a procedure variable is required to calculate the result: Create a procedure variable (K) with &lt;Add&gt;.</p>	
<div style="display: flex; justify-content: space-between; padding: 5px;"> <span>Back</span> <span>Add</span> <span> </span> <span>Next</span> </div>	

Create all required flow variables.

- 5** Use *[Add]* to create a flow variable required for the formula and enter a name, e.g. the measurement variable.
- or
- Use *[Next]* to take over all entries and move to the next page.

Procedure variables	16.01.17 9:52
K 1	V (extract)
K 2	V (sample)
<div style="display: flex; justify-content: space-between; padding: 5px;"> <span>Back</span> <span>Add</span> <span>Delete</span> <span>Next</span> </div>	

- 6** Use *[Add]* to add an additional wavelength.
- or
- Use *[Delete]* to delete the marked wavelength.
- 7** Use *[Next]* to take over all entries and move to the next page.

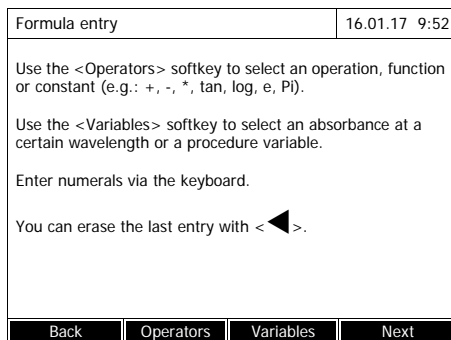

Enter the formula.

- 8** Use **<0...9>** to input numbers.  
 Use **[Operators]**, **<▲><▼>**  
**<◀><▶>** and  
**<START-ENTER>** to select an  
 operator, a function or constant.  
 Use **[Variables]**, **<▲><▼>**  
**<◀><▶>** and  
**<START-ENTER>** to select a  
 variable.

The formula is displayed after each step.

Use **<◀>** to remove the last element of the formula.

Use **[Back]** to exit the formula editor.

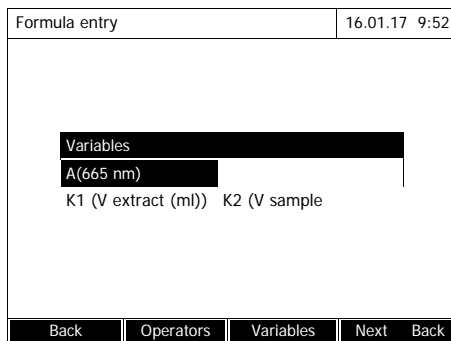

- 9** Use **[Variables]**, **<▲><▼>**  
**<◀><▶>** and  
**<START-ENTER>** to select a  
 variable and confirm.  
 The current status of the formula is  
 displayed.

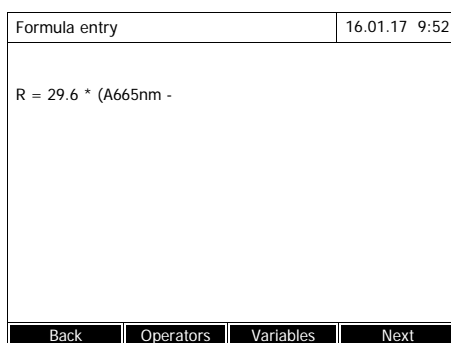

- 10** Insert operator.  
 The current status of the formula is  
 displayed.



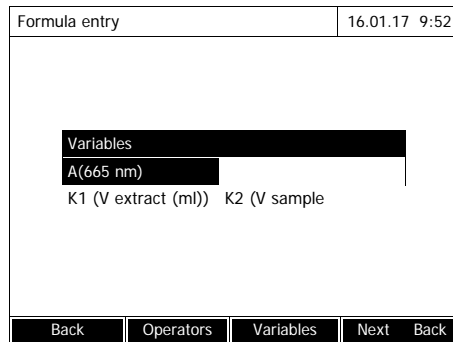

**11** Use [Variables], <▲><▼> <◀><▶> and <START-ENTER> to select Variable A<sub>665 nm</sub> and confirm. The current status of the formula is displayed.

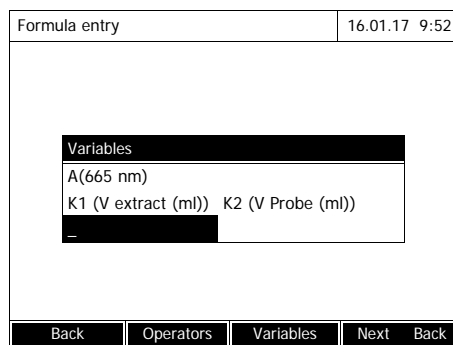

**12** Using [Variables], <▲><▼> <◀><▶> and <START-ENTER> select underscore (\_) The input field pops up where you can enter an index for the measurement, e.g. 2 for the second measurement at this wavelength. Confirm the index entered. The current status of the formula is displayed.

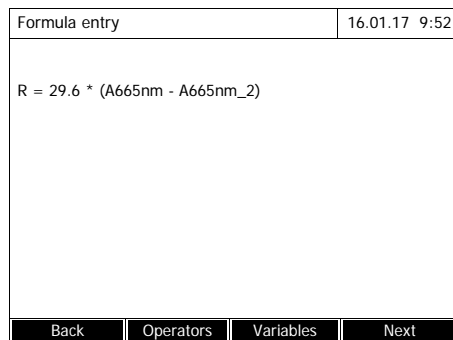

**13** Complete the formula. The current status of the formula is displayed.

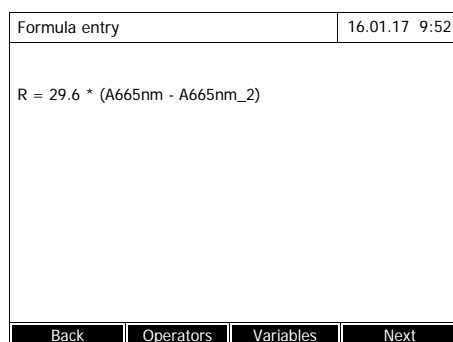

**14** Use .17 to take over all inputs and change to the next page. If an error is in the formula, an error message appears. The formula editor is only exited once the error is eliminated.

Condition	16.01.17 9:52
<p>Here you can enter a formula for a condition. The measured value is only valid if this condition is met.</p>	
Back	Operators Variables Next

If necessary, input the formula for a condition.

**15** Use **<0...9>** to input numbers.

Use *[Operators]*, **<▲><▼>** **<◀><▶>** and **<START-ENTER>** to select an operator, a function or constant.

Use *[Variables]*, **<▲><▼>** **<◀><▶>** and **<START-ENTER>** to select a variable.

The condition is displayed after each step.

Use **<◀>** to remove the last element of the formula.

Use *[Back]* to exit the formula editor.

Condition	16.01.17 9:52
<p>A665 nm &lt;sup&gt;2&lt;/sup&gt;</p> <p>b5</p>	
Back	Next

**16** Complete the condition.

**17** Complete the programming of the method with *[Next]*.

Edit method	16.01.17 9:52
Sequence	Designation
Measurement	_____
Measurement	_____
Back	Next

If the formula includes several measurements for the same wavelength (measurement sequence), you can assign names for the individual measurements of the sequence.

**18** Enter the names for the individual measurements of a sequence.

Edit method		16.01.17 9:52	
Sequence		Designation	
Measurement		before	
Measurement		after	
Back		Next	

19 Complete the programming of the method with *[Next]*.

Special / Multi wavelengths		16.01.17 9:52	
V extract (ml)			
Press <START/ENTER> to enter the value			
2001:Chl a 10 mm		Chlorophyll a	
Setup	Method list	Citation form	Unit

The method is programmed and selected.  
The photometer is ready for measurement.

### 4.7.3 Selecting a Special / Multi wavelengths method

Here's how to select a method for Special / Multi wavelengths measurements:

```

<HOME>
Special / Multi wavelengths
├─ [Method list]
    
```

Select method (all)		16.01.17 9:52	
<input type="text"/>			
2517	ADMI 10	Pt-Co Units	
2518	ADMI 50	Pt-Co Units	
Last used			

The list of methods is displayed. The methods are sorted by method number.

Select method:

- 1 Use <▲><▼> to select the desired method. The current selection is displayed in reverse video.
- 2 Use <START-ENTER> to take over the selection.

The photometer is ready for measurement.

**Restricting the method list**

If the list is very long, you can restrict the method list as follows and thus make the search easier:

- With *[Last used]* you can restrict the method list to the ten last methods used.
- With the search function you can search certain character strings such as method number or test name in the list.

**Search function**

Select method (last used)	16.01.17 9:52	
ADM		
2517	ADMI 10	Pt-Co Units
2518	ADMI 50	Pt-Co Units
All methods		

Search for character string:

Use **<A...9>** to enter the character string you want to search for in the search window.

The list below displays all hits that include the character string. With each character input, the hit list is updated.



When searching, pay attention to the correct upper and lower case.

**4.7.4 Carrying out Special / Multi wavelengths measurements**

**<HOME>**  
*Special / Multi wavelengths*

Special / Multi wavelengths	16.01.17 9:52	
Please select method for measuring!		
Setup	Method list	Citation form
Unit		

- 1 Use *[Method list]* to select the desired method (see Section 4.7.3).

For the description of the measurement flow, the self-programmed method "Chl a" is selected.

Special / Multi wavelengths	16.01.17 9:52
<p>V extract (ml)</p> <p>Press &lt;START/ENTER&gt; to enter the value</p>	
2001:Chl a 10 mm	Chlorophyll a 0.00 - 1000.00 µg/l
Setup	Method list Citation form

For methods with procedure variables: Enter the values of all procedure variables one after the other.

**2** Use <START-ENTER> to continue to the next step.

Special / Multi wavelengths	16.01.17 9:52
<p>V extract (ml) 10 ml V sample (ml) 100 ml</p> <p>Proceed with &lt;START/ENTER&gt;</p>	
2001:Chl a 10 mm	Chlorophyll a
Setup	Repeat Cancel

**3** The instructions on the display follow.

**4** Enter the volumes of sample and extract.

If necessary, repeat the last step with *[Repeat]*.

**5** Use <START-ENTER> to continue to the next step.

The photometer is ready for measurement.

Special / Multi wavelengths	16.01.17 9:52
<p>Measurement 1</p> <p>Zero measurement required!</p> <p>Press &lt;ZERO/BLANK&gt;</p>	
2001:Chl a 10 mm	Chlorophyll a 0.00 - 1000.00 µg/l
Setup	Method list Citation form Unit

If necessary, carry out a zero measurement.

Special / Multi wavelengths	16.01.17 9:52
<p>Measurement 1</p> <p>To start measurement, insert cell or press &lt;START/ENTER&gt;</p>	
2001:Chl a 10 mm	Chlorophyll a
Setup	Method list Citation form Unit

The photometer is ready for measurement.

**6** Use <START-ENTER> to continue to the next step.

**7** Insert cell (round cell or rectangular cell)(see Section 4.2.5 INSERTING A CELL).

Special / Multi wavelengths	16.01.17 9:52
<p>Measurement 1</p> <p>To start measurement, insert cell or press &lt;START/ENTER&gt;</p> <p>2001:Chl a Chlorophyll a 10 mm</p>	
Setup	Cancel

**8** Start the measurement.

Special / Multi wavelengths	16.01.17 9:52	
<p>V extract (ml) 10 ml V sample (ml) 100 ml Measurement 1 A(665 n) = 0.600</p> <p>Proceed with &lt;START/ENTER&gt;</p> <p>2001:Chl a Chlorophyll a 10 mm</p>		
Setup	Repeat	Cancel

In case of several measurements, an intermediate result is displayed.

**9** Use <START-ENTER> to continue to the next step.

Special / Multi wavelengths	16.01.17 9:52	
<p>Measurement 2</p> <p>To start measurement, insert cell or press &lt;START/ENTER&gt;</p> <p>2001:Chl a Chlorophyll a 10 mm</p>		
Setup	Repeat	Cancel

**10** Start the measurement.

Special / Multi wavelengths	 16.01.17 9:52
<p>V extract (ml) 10 ml V sample (ml) 100 ml Measurement 1 A(665 n) = 0.600 Measurement 2 A(665 n) = 0.000</p> <p><b>1.78</b> mg/ml</p> <p>Start new analysis with &lt;START/ENTER&gt;</p>	
Setup	Cancel

The result is shown.

If a condition entered is not fulfilled, no measurement value is displayed.

**11** If necessary, start a new measurement with the method.

## 4.8 Spectrum

### 4.8.1 General information

With the *Spectrum* function, the *Absorbance* or *Transmission* is measured and recorded depending on the wavelength. The wavelength range can be freely selected within the measuring range of the photometer. The increment is 1 nm.

A spectrum is recorded without using any methods or profiles. All settings are made in the measurement process.

#### Baseline

Before recording a spectrum, a baseline must be recorded with a suitable zero cell, e.g. with deionized water. The baseline must cover at least the wavelength range of the spectrum to be recorded. A baseline measured once remains stored in the photometer until

- the recording of a new baseline
- the expansion of the wavelength range on the *[Setup]* menu
- exiting the *Spectrum* mode or switching off the photometer.

#### Settings

You can record a spectrum with standard settings without opening the setting window.

The following settings are possible for a spectrum:

Input field	Possible entries
<i>Wavelength start</i>	320* ... 1100 nm
<i>Wavelength stop</i>	320 ... 1100* nm
<i>Mode</i>	<i>Absorbance*</i> or <i>Transmission</i>
<i>Smoothing</i>	<i>Yes*</i> or <i>No</i>
<i>Color of graph</i>	Color selection for the curve
<i>Scaling</i>	<i>Auto*</i> or <i>Manual</i>
<i>Scaling: Auto*</i>	The instrument adjusts the axis scaling (minimum and maximum values of the axis) to the measurement values during the measurement. The entire line is always visible.
<i>Scaling: Manual</i> <i>Y-axis min</i> <i>Y-axis max</i>	The axis scaling (minimum and maximum values of the axis) is specified manually.

\* Default setting:



With *[Save]* you can save your current settings as profile.  
With *[Open]* you can load a saved profile.  
Profiles for spectra have the file extension, ".profil".

### 4.8.2 Recording a Spectrum

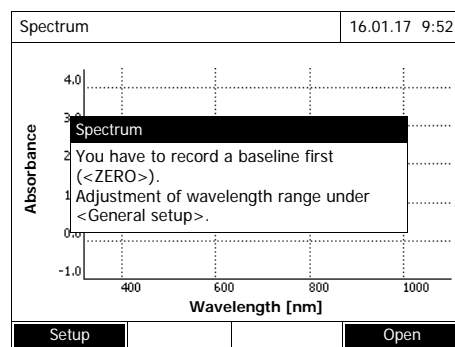
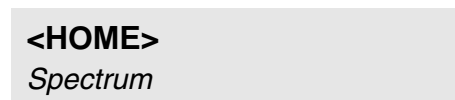

Spectrum		16.01.17 9:52
Wavelength start		
Wavelength stop		1100 nm
Mode		Absorbance
Smoothing		Yes
Color of graph		Blue
Scaling		Auto
		Apply

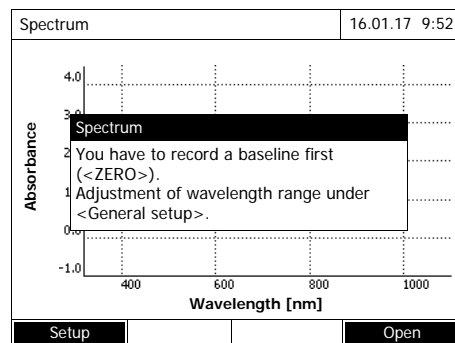

A message with operating instructions is displayed.

- 1 Open the settings menu with [Setup].
- 2 If necessary, change the default settings for the spectrum.
  - Wavelengths for start and end point of the spectrum to be recordedx
  - Display mode (*Absorbance-Transmission*)
  - Curve smoothing (*Yes/No*)
  - Color of the curve
  - Scaling of the Y-axis  
*Auto:* (total value range)  
*Manual:* (selected value range)
- 3 Use [Apply] to take over all entries.

A message with operating instructions is displayed.



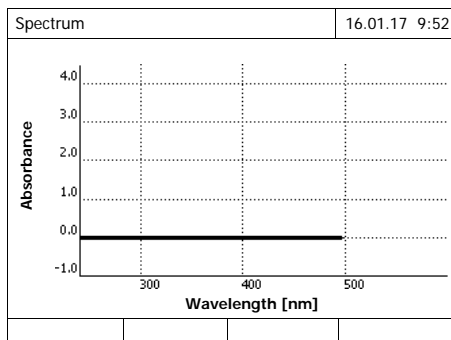

Recording the baseline:

- 4 Press **<ZERO-BLANK>**.  
The photometer records the baseline.
- 5 Wait until the baseline has been recorded completely.

The photometer is ready to measure after the baseline has been recorded.

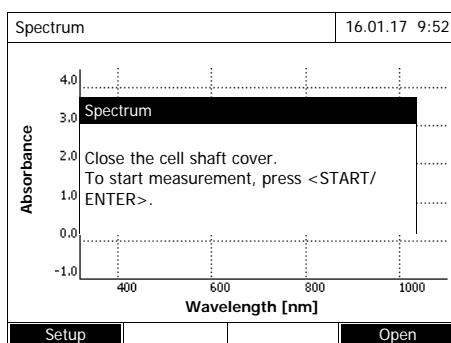

Recording the spectrum:

- 6 Insert cell (round cell or rectangular cell)(see Section 4.2.5 INSERTING A CELL).
- 7 Start the measurement with **<START-ENTER>**.

After recording the spectrum, the message *Recording of spectrum is completed.* appears

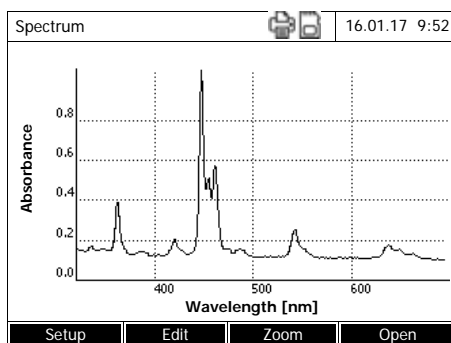

- 8 Wait until the spectrum has been recorded completely.  
At the end of the recording, the message appears: *Recording of spectrum is completed.*
- 9 Confirm the message with **<START-ENTER>**.

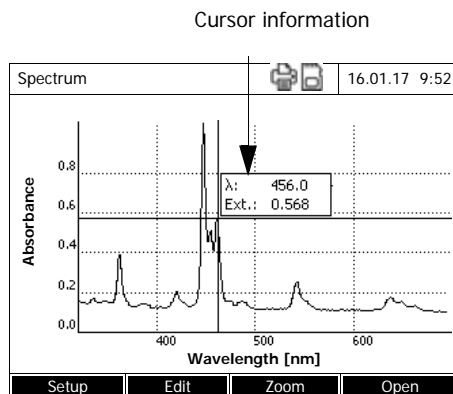

The cursor is shown on the absolute maximum of the spectrum.

**10** You have the following possibilities:

- Edit the spectrum immediately (see Section 4.8.3)
- With **<PRINT>** you can output the spectrum as graphic to a connected printer or as pdf file .
- With **<STORE>** you can save the spectrum as \*.csv file. As storage location, you can select the photometer (*Internal DataB folder*) or a connected USB storage medium on the USB-A connection (*USB memory*). Stored spectra can be called up and edited at any time (see Section 4.8.3).

### 4.8.3 Loading/editing a spectrum

A spectrum can be edited immediately after measurement. Stored spectra can be loaded and edited as well.

The following tools are available for editing:

- Cursor function for step-by-step sampling of the curve with display of the x- and y-values
- Zoom function to scale up a section
- Mathematical functions for various evaluating and calculating operations. The functions are described starting on Page 92.

#### Loading a stored spectrum

```
<HOME>
Spectrum
- [Open]
```

Open (Internal DataB folder)		16.01.17 9:52
26.02.17	Holmium.csv	
23.02.17	K2Cr2O7_340nm.csv	
Location		Delete

The list with the spectra saved in the exchange memory is displayed.

- 1 You can use *[Location]* to select another storage location for the spectrum if necessary (USB storage medium on the USB-A connection).

- 2 Select the desired spectrum.

The original view of the line is shown.

### Cursor

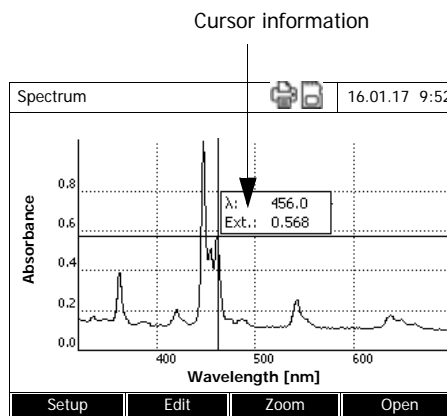

The cursor consists of a horizontal and a vertical line, which cross at a point of the curve. A box displays the x and y values of the curve point.

With *<<>>* you can move the cursor along the x axis (wavelength). This way, you can sample and evaluate the curve point by point.

### Zoom

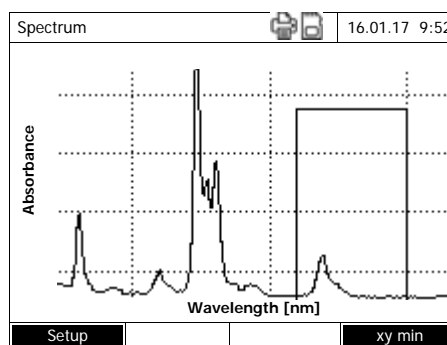

- 1 Press *[Zoom]*.

The zoom window is displayed. The lower left corner of the zoom window is marked with a small black square.

- With *[Original]* you can return to the original view of the spectrum at any time.

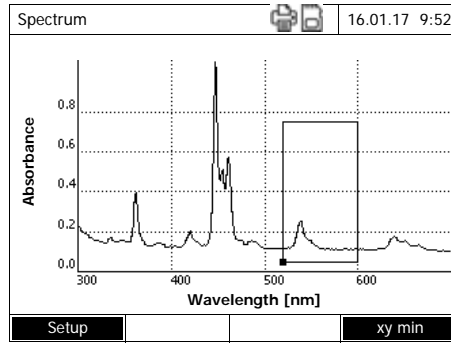

**2 Adjusting the zoom window:**

- With <◀><▶> and <▲><▼> you can specify the lower left corner of the zoom window.

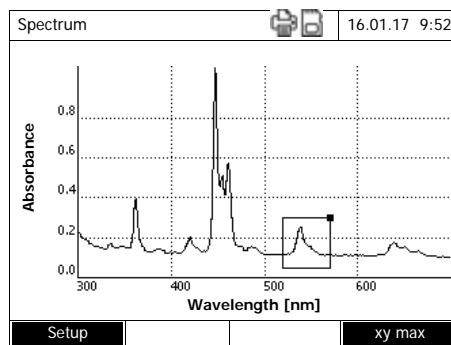

- With [xy max] you can mark the upper right corner of the zoom window (small black square).
- With <◀><▶> and <▲><▼> you can specify the right top corner of the zoom window.

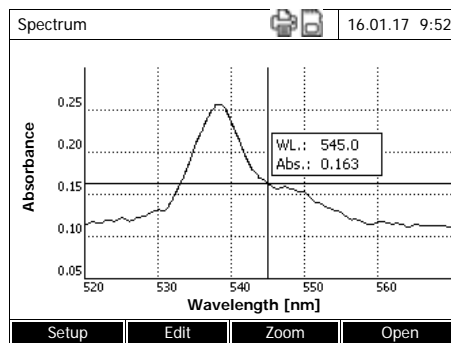

**3 Enlarge the zoom window:**

- Press <START-ENTER>. The zoom window is scaled up on the entire diagram area.

Leaving the zoom view:

- With <ESC> you can return to the original view of the spectrum.

**Edit** Use [Edit] to open the palette for the mathematical functions:

- *Extreme values (zoomed area)*  
Marks the extreme values (minimums and maximums) on the spectrum displayed
- *Mark points*  
Opens an edit mode for marking individual points on the spectrum  
You can mark individual points with the [Mark] function key.  
The wavelength and measured value are displayed at the highlighted point.  
You can remove individual points with the [Delete] function key.
- *Delete all marks*

Deletes all marked points on the spectrum.

- *Original*  
Displays the original, unedited spectrum.
- *Integral*  
Calculates the area between the zero line and the curve within a freely-selectable wavelength interval [X1,X2].
- *Derivative*  
Calculates the derivation of the entire spectrum. To calculate the second and third derivative, the function can be carried out several times.
- *Compare spectrum*  
Loads a second spectrum into the same diagram for direct comparison. The second spectrum is displayed in the color magenta.
- *Add spectrum*  
Adds a stored spectrum to the current spectrum.
- *Subtract spectrum*  
Subtracts a stored spectrum from the current spectrum.
- *Divide spectrum (ratio)*  
Divides the absorbance or % transmission values of the current spectrum by the values of a stored spectrum
- *Add fixed value*  
Adds a fixed absorbance or % transmission value to the current spectrum.
- *Multiply fixed value*  
Multiplies the absorbance or % transmission values of the current spectrum by a fixed value.



The addition, subtraction and division of two spectra always applies to the common wavelength range of both spectra only.

#### 4.8.4 Saving / exporting a spectrum

The saving of a spectrum saves both the edited and the original spectrum. Consequently, the original spectrum can be restored from each stored spectrum.

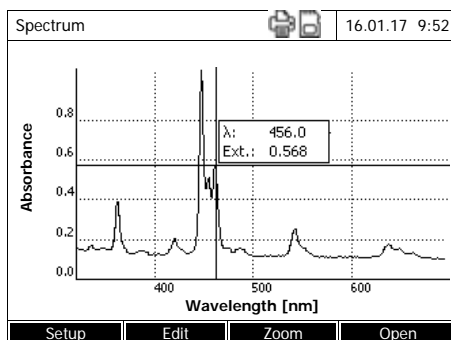
**Save**

- 1 Record spectrum (see Section 4.8.2)  
or  
Load stored spectrum (see Section 4.8.3).
- 2 If necessary, connect a USB storage medium to the USB-A interface.
- 3 Open the save dialog with **<STORE>**.
- 4 If necessary, change the storage location with *[Location]*:  
*Internal DataB folder*:  
Exchange folder on the instrument  
or  
*USB memory*:  
connected USB storage medium  
on the USB-A connection.
- 5 If necessary, change the file name.  
The photometer automatically offers a unique file name consisting of wavelength range, date and time.
- 6 Use **<START-ENTER>** to save the file.

**Export to a PC** Export a stored spectrum to a PC: see Section 4.12.3

## 4.9 Kinetics

The Kinetics function allows the temporal tracing of the absorbance and transmission of a sample with a particular wavelength.

The photometer automatically calculates the slope between two adjacent measuring points from the available measurement data. If necessary, the catalytic activity can also be determined and displayed.

To record the kinetics, the photometer carries out single measurements at regular time intervals (measurement intervals) and saves the measurement values as a function of the time.

All settings for a recording are administrated as a profile. Profiles can be created, stored, edited and deleted. Each measurement assumes an appropriate profile.

### 4.9.1 Creating/editing profiles for Kinetics recordings



Profiles for Kinetics recordings are saved under the numbers 4001 to 4020. In the delivery condition, a profile is stored for demonstration purposes.

A profile for a Kinetics recording includes the following details:

Input field	Possible entries
<i>Number</i> *	4001 ... 4020
<i>Name</i>	Arbitrary name (max. 18 characters)
<i>Mode</i> *	<i>Absorbance or Transmission</i>
<i>Wavelength</i> *	Freely selectable (in nm)
<i>Duration</i> *	Total duration in the format hh:mm:ss (Hours:Minutes:Seconds)
<i>Interval</i> *	Measurement interval = temporal distance between two sequential single measurements in the format hh:mm:ss (hours:minutes:seconds)  Exception: For the setting <i>Measurements/interval: Max/interval</i> the interval is defined differently (see below).
<i>Delay</i>	Time between the start of recording and the beginning of the first single measurement

Input field	Possible entries
<i>Scaling</i>	<i>Auto</i> or <i>Manual</i>
<i>Scaling: Auto</i> **	The instrument adjusts the axis scaling (minimum and maximum values of the axis) to the measurement values during the measurement. The entire line is always visible.
<i>Scaling: Manual</i> <i>Y-axis min</i> <i>Y-axis max</i>	The axis scaling (minimum and maximum values of the axis) is specified manually.
<i>Measurements/interval</i>	<i>1/interval</i> or <i>Max/interval</i>  Here you define how many measurements are carried out per interval.  This setting affects the calculation of the slope of the individual intervals (seeSection 4.9.6 ).
<i>Catalytic activity</i>  (only for <i>Mode: Absorbance</i> )	<i>Yes</i> or <i>No</i>  Here you determine whether the catalytic activity should be calculated.  The catalytic activity is a measure for the amount of substance that is converted per time unit. To accelerate the substance conversion, a catalyst or enzyme (biological catalyst) is used in most cases.  Carry out the measurement at room temperature.
<i>Catalytic activity: Yes</i>  <i>Factor</i> <i>Unit</i> <i>Resolution</i>	The catalytic activity or enzyme activity is calculated from the slope of the line.  <div style="border: 1px solid black; padding: 2px; width: fit-content; margin: 5px 0;"><math display="block">\text{Cat. A.} = \text{average value Slope } [\Delta / \text{min}] \text{Factor}</math></div> You can enter the value for <i>Factor</i> here.  Together with the unit and resolution selected here, the calculated value for the catalytic activity is displayed on the <i>[Edit] / Slope &amp; catalytic activity</i> menu.

\* mandatory inputs  
\*\* Default setting: *Auto*



## Creating/editing profile

```

<HOME>
Kinetics
  - [Setup]
    | Edit profile
  
```

Edit profile (1 of 2)		16.01.17 9:52
Number	<input type="text" value="4001"/>	
Name	NADH	
Mode	Absorbance	
Wavelength	340 nm	
Duration	02:00:00	
Interval	00:00:30	
Delay	00:01:00	
Scaling	Auto	
<input type="button" value="Profile list"/> <input type="button" value="Delete"/> <input type="button" value="Next"/>		

**1** Enter the data for the profile here. The next available profile number is already entered as number.

You have the following possibilities for filling out the input fields:

- Fill out all blank input fields in sequence
- Use *[Profile list]* to select an already existing profile as template, assign it a new profile number, and adjust the entries
- Use *[Profile list]* to select an existing profile for editing (without changing the number).
- Use *[Delete]* to delete the profile completely.

**2** Use *[Next]* to change for additional settings.

Edit profile (1 of 2)		16.01.17 9:52
Measurements/interval	<input type="text" value="1/interval"/>	
Catalytic activity	Yes	
Factor	1.000	
Unit	kat	
Resolution	0.01	
<input type="button" value="Back"/> <input type="button" value="Complete"/>		

**3** Enter further data for the profile here.

**4** Use *[Complete]* to take over all entries.

The profile is created and selected. The photometer is ready for measurement.



The *Catalytic activity* function is only available if the Absorbance mode was selected.

### 4.9.2 Loading profile for Kinetics recording

Here's how to load a profile for a Kinetics recording:

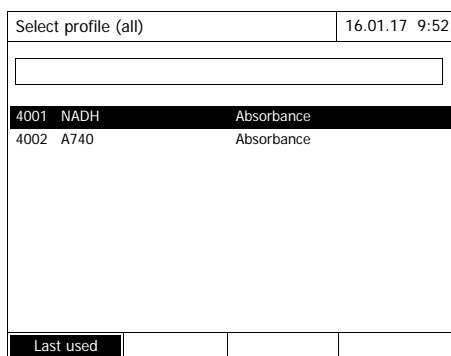

The list of profiles is displayed. The profiles are sorted by profile number.

Select profile:

- 1 Select the desired profile with <▲><▼>. The current selection is displayed in reverse video.
- 2 Use <START-ENTER> to take over the selection.

The photometer is ready for measurement.

#### Restricting the list of the profiles

If the list is very long, you can restrict the profile list as follows and thus make the search easier:

- With [Last used] you can restrict the profile list to the ten last profiles used.
- With the search function you can search certain character strings such as method number or test name in the list.

#### Search function

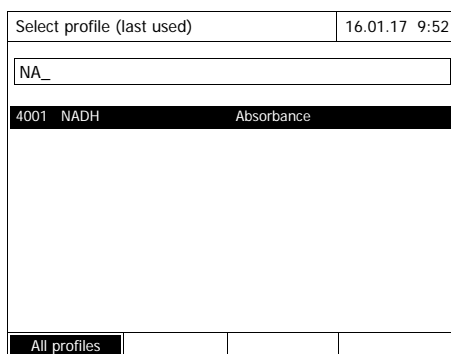

Search for character string:

Use <A...9> to enter the character string you want to search for in the search window.



When searching, pay attention to the correct upper and lower case.

### 4.9.3 Recording Kinetics

<HOME>  
Kinetics

Kinetics	16.01.17 9:52
Zero measurement required! Press <ZERO/BLANK>	
4001: Demo	Absorbance
Setup	Profile list
	Open

- 1 If necessary, select another profile with *[Profile list]* (see Section 4.9.2).
- 2 Start the zero measurement with **<ZERO-BLANK>**.

Kinetics	16.01.17 9:52
Please insert zero cell (distilled water) or press <START/ENTER>	
10 mm	0.0 - 22.1 mg/l
Setup	Profile list
	Open

- 3 Perform zero measurement.

Kinetics	16.01.17 9:52
[ZERO 16.01.17 9:51]	
Close the cell shaft cover. To start measurement, press <START/ ENTER>.	
10 mm	0.0 - 22.1 mg/l
Setup	Profile list
	Open

The photometer is ready for measurement.

- 4 Insert a cell (see Section 4.2.5 INSERTING A CELL).
- 5 Start the measurement with **<START-ENTER>**.

The photometer starts recording automatically.

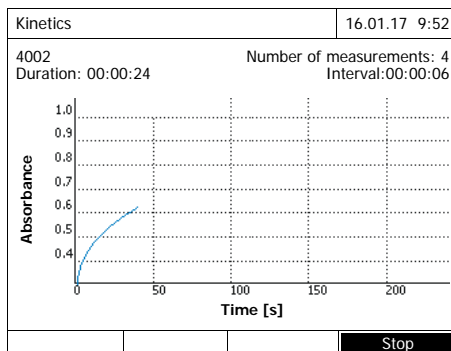

6 Wait until the recording is complete.

Cancellation possibilities:

- Use [Stop] to interrupt the recording. The curve recorded up to this point can be saved and edited (see Section 4.9.6).
- Use <ESC> to interrupt the measurement entirely. The curve recorded up to this point is discarded.

Cursor information

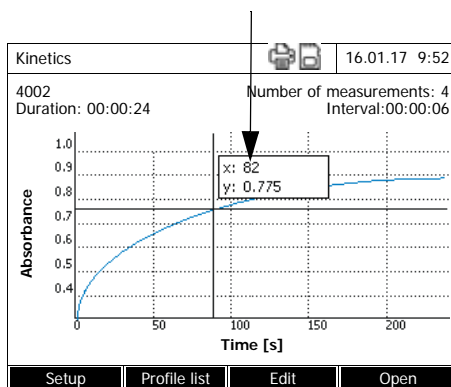

7 After elapsing of the set *Duration* the cursor is shown.

You have the following possibilities:

- You can sample the curve with the cursor and display the measurement data for each point (see Section 4.9.6)
- With <PRINT> you can output the kinetics curve as graphic to a connected printer or as pdf file.
- You can store the stored kinetics curve with <STORE> (see Section 4.9.4).
- Perform additional functions for editing the kinetics recording (see Section 4.9.6)
- Close the kinetics recording with <ESC>.

### 4.9.4 Saving/exporting a Kinetics recording

#### Save

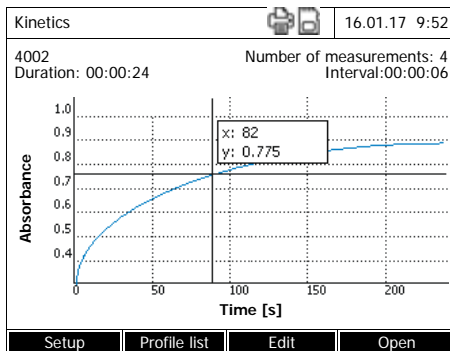

- 1 Make kinetics recording (see Section 4.9.3) or load saved kinetics recording (see Section 4.9.4).
- 2 If necessary, connect a USB storage medium to the USB-A interface.
- 3 Open the save dialog with **<STORE>**.
- 4 If necessary, change the storage location with *[Location]: Internal DataB folder*. Exchange folder on the instrument or *USB memory*: connected USB storage medium on the USB-A connection.
- 5 If necessary, change the file name.
- 6 Use **<START-ENTER>** to save the file.

#### Export to a PC

Export a stored kinetic record to a PC: see Section 4.12.3

#### Example of a kinetics recording (\*.csv file)

```
6|4001|1|1|525|1280913092|59|5|1|0.000|0.301|0|1.000|µkat|2
Device: Serial number:Software: User:
XD 700009130512 2.70-Tintometer-0.14 Administrator

Start time Wavelength [nm]
04.08.2010 11:11 525

Time [s] Absorbance
0 0,092
5 0,077
10 0,073
15 0,069
.. .....
```

Line 1 - explanations:

Column	Value	Explanation
1	6	Version of the file format for the CSV file
2	4001	Profile number
3	1	Measurement of absorbance (0) or transmission (1)
4	1	Measurement 1x per interval (0) or as often as possible (1)
5	525	Wavelength (in nm)
6	1280913092	Start time (internal data format)
7	59	Duration (in sec)
8	5	Interval time (in sec)
9	1	Scaling automatic (0) or manual (1)
10	0.000	Minimum with manual scaling
11	0.301	Maximum with manual scaling
12	0	Enzyme activity from (0) or one (1)
13	1.000	Enzyme activity factor
14	µkat	Enzyme activity unit
15	2	Enzyme activity decimal places

#### 4.9.5 Loading a Kinetics recording

You can load and view saved Kinetics recordings.

#### Loading a saved Kinetics recording

```
<HOME>
Kinetics
- [Open]
```

		16.01.17 9:52
26.02.17	Enzyme kinetics.csv	
24.02.17	A740.csv	
24.02.17	kinetics_4002_070224_1410.csv	
Location		Delete

The list with the saved Kinetics recordings (*Internal DataB folder*) is displayed.

- 1 Use *[Location]* to select the storage location of the kinetics recording (*Internal DataB folder* or *USB memory* for a USB storage medium on the USB-A connection).
- 2 Select the desired Kinetics recording.

The curve is loaded.

You have the following possibilities:

- You can sample the curve with the cursor and display the measurement data for each point (see Section 4.9.6)
- With **<PRINT>** you can output the kinetics curve as graphic to a connected printer or as pdf file.
- You can store the stored kinetics curve with **<STORE>** (see Section 4.9.4).
- Execute additional functions for editing the kinetics recording (see Section 4.9.6)
- Close the kinetics recording with **<ESC>**.

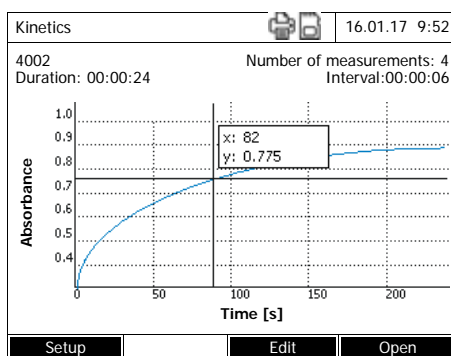

#### 4.9.6 Editing a Kinetics recording

The following functions are available for kinetics recordings:

- Sampling the curve with the cursor
- Display of a list with the slopes of the curve for each interval
- Scaling the Y-axis of the diagram
- Joint display of two kinetics recordings in one graphic
- Display of the difference of two kinetics recordings

**Cursor**

**Cursor information**

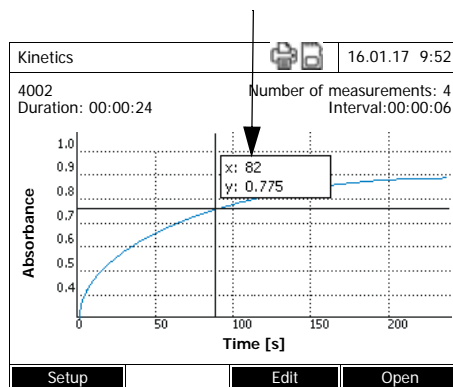

The cursor consists of a horizontal and a vertical line, which cross at a point of the curve. A box displays the x and y values of the curve point.

With  $\leftarrow \rightarrow$  you can move the cursor along the x-axis (time axis). This way, you can sample and evaluate the curve point by point.

**Slope of the curve & catalytic activity**

The *Slope & catalytic activity* function displays the slope of the kinetics curve in the individual segments (intervals) of the curve.

A section corresponds to the *Interval* entered in the profile.

- 1 Use *[Edit] / Slope & catalytic activity* to display the slope of the kinetics curve in the individual sections (intervals).

Interval	Slope [ $\Delta/\text{min}$ ] ( $\Delta/\text{Time}$ )	Time
1	0.000	5 s
2	0.000	10 s
3	0.000	15 s
4	0.000	20 s
5	0.000	25 s
6	0.000	30 s

If during creation of a profile the calculation of the catalytic activity was selected, it is displayed here together with the slope.



The *Slope & catalytic activity* function is only available if the kinetics recordings were made in Absorbance mode.

The slope displayed for an interval is determined as follows depending on the profile:

<i>Measurements/interval</i>	<b>Slope</b>
<i>1/interval</i>	Slope, converted to the interval "1 minute"
<i>Max/interval</i>	Slope of the straight lines determined in an interval through linear regression, converted to the interval "1 minute"



**Scaling of the y-axis**

With *[Setup]/Scaling/Manual* you can specify the scaling of the y-axis manually.

**Compare kinetics**

With *[Edit] / Compare kinetics* you load a second kinetics recording into the same diagram for direct comparison.



The *Compare kinetics* function is only available if the kinetics recordings were made in Absorbance mode.

**Subtract kinetics**

With *[Edit] / Subtract kinetics* you subtract a stored kinetics recording from the current kinetics recording.



You can only execute the *Subtract kinetics* function if both kinetics recordings were done with the following settings:

- Mode: Absorbance
- Measurements/interval: 1/interval
- Same interval

## 4.10 Timer

You can use timers in order to remind yourself with an acoustic signal about the elapsing of a time interval.

The photometer recognizes two types of timers:

- *User defined timer* (user-defined timer) is a freely-programmable timer. The interval and name can be freely set. Only one freely assignable timer is available. It cannot be deleted (see Section 4.10.1).
- *Analysis timers* are timers that are stored permanently in the instrument. Name and interval of the analysis timers are stored in the method data of a measurement method (*Concentration* mode). The number of available analysis timers corresponds to the number of reaction times that are prescribed in the analysis specifications for the programmed methods (see Section 4.10.2).

The photometer administrates all timers in the timer overview.

You open the timer overview (the *Timer* menu) with the **<TIMER>** button. Opening the *Timer* menu is possible in any operating situation. Other functions are not disturbed by operation of the timer. You exit the time overview with the **<ESC>** key.

When the *Timer* menu is opened for the first time, only the user-defined timer is in the timer overview. You can include analysis timers into the list or remove them according to your requirements (see Section 4.10.2).

The timer overview displays the status of each timer and, of a started timer, the remaining time of the specified time interval.

All timers are started manually.

As soon as one single timer has been started the timer symbol appears on the display in all operating modes.

As soon as a timer is started, it is given the timer status *Active*.

When the specified time interval has expired, the timer status changes from *Active* to *Expired* and an audio signal sounds.

In the timer status *Expired* the acoustic signal sounds until the timer is stopped manually.

After the stop, the timer status changes to *Inactive* and the acoustic signal is switched off.

### 4.10.1 User defined timer

If you want to manually enter time intervals, use the *User defined timer* function.

**<TIMER>**

Timer		16.01.17 9:52
Designation	Time	Status
User defined timer	00:15:00	Inactiv
- 1	00:15:00	Inactiv

Start   Stop   Edit   Add

The *Timer* menu opens.

- 1 Highlight the *User defined timer*.
- 2 If necessary, change the name and time of the timer with *[Edit]*.
- 3 Start the highlighted timer with *[Start]*.

The status of the timer is *Active*. When the specified time interval has expired, and audio signal sounds and the timer status changes to *Expired*.

- 4 Stop the highlighted timer with *[Stop]*.

The status of the time changes to *Inactive*. The audio signal is switched off.

#### 4.10.2 Analysis timer

Between the individual steps of a measurement, reaction times often have to be observed. The length of the reaction time is defined in the relevant analysis instructions.

For all required reaction times, the analysis timers with the corresponding time intervals are stored in the instrument. The names of the analysis timers include the method name and a current number so several timers within a method can be distinguished from each other.

To be able to use an analysis timer for a method you have to load it first in the timer overview.

To do so, first select the required method and then add the available analysis timers to the timer overview so they can be started as necessary.

The timer overview always comprises the free timer and the selected analysis timers.

- 1 Select the required method in the *Concentration* mode.

Manual selection of the method (see Section 4.5.5).

## &lt;TIMER&gt;

Timer	16.01.17 9:52	
Designation	Time	Status
User defined timer	00:15:00	Inactiv
- 1	00:15:00	Inactiv
Start	Stop	Remove Add

2 Open the Timer menu.

The *Timer* menu opens.

3 If necessary, add a new timer to the list with *[Add]*.

Note:

The *[Add]* function key is only displayed if a method is selected for which analysis timers were programmed but are not yet displayed in the list of timers.

4 Highlight an analysis timer.

5 If necessary, remove the analysis timer from the list with *[Remove]*.

6 Start the highlighted timer with *[Start]*.

The status of the timer is *Active*. When the specified time interval has expired, and audio signal sounds and the timer status changes to *Expired*.

7 Stop the highlighted timer with *[Stop]*.

The status of the time changes to *Inactive*. The audio signal is switched off.

## 4.11 Memory

### 4.11.1 Overview

Measured data	Save, back up, export
<p><i>Concentration,</i> <i>Absorbance / % Transmis-</i> <i>sion</i> <i>Special / Multi wavelengths</i></p>	<p>Measurement datasets of these measuring modes are first stored in the measured value memory of the photometer (5000 memory locations) with <b>&lt;STORE&gt;</b> or <i>AutoStore</i>.</p> <p>The measured value memory is available from the <i>Measurement data memory</i> menu. Here you can view, filter and export into a PC-readable file (*.csv) the stored measurement datasets (<b>&lt;STORE&gt;</b>).</p> <p>Csv files of these measuring modes cannot be reimported to the photometer.</p> <p>Measurement datasets of these measuring modes can also be stored to a pdf file (see Section 4.11.11).</p>
<p><i>Spectrum</i> <i>Kinetics</i></p>	<p>You can store and export measurement data of these measuring modes directly as a PC-readable file (*.csv) with <b>&lt;STORE&gt;</b>.</p> <p>Csv files of these measuring modes can be reimported and displayed on the photometer.</p> <p>Measurement data of these measuring modes can also be stored to a pdf file (see Section 4.11.11).</p>
<p>DeviceCheck protocols</p>	<p>You can store and export measurement data of these measuring modes directly as a PC-readable file (*.csv) with <b>&lt;STORE&gt;</b>.</p> <p>Csv files of records cannot be reimported to the photometer.</p> <p>Measurement data of these measuring modes can also be stored to a pdf file (see Section 4.11.11).</p>
<p>User-defined methods / profiles</p>	<p>Method data and profile data are stored and exported with the <i>Exchange methods/profiles</i> function in the <b>&lt;HOME&gt;/General setup</b> menu.</p>

For each export procedure you can select the location where the PC-readable files (\*.csv, \*.pdf) should be stored: either to the photometer (*Internal DataB folder*) or an external memory (*USB memory*). On an external storage medium the data is stored in the directory "DataB XD 7....".

The files stored in the photometer (*Internal DataB folder*) can later be transferred to a connected PC or to an external memory (*USB memory*).

#### 4.11.2 Instructions on using USB memory devices

The safety of data stored on USB memory devices depends on the quality of the memory device and the data transmission.

Data is stored partly or not at all if for example:

- The power supply of the external memory device is interrupted during the write process, or
- The external memory device is prematurely disconnected from the photometer during the data backup.

To prevent a data loss we recommend the following:

- Save all data internally in the photometer first.
- After performing a backup leave the USB memory device connected to the photometer for some time.
- Check whether the stored data is complete, e.g. on a PC.
- Use the USB memory device for data transport but not for permanent data storage.

#### 4.11.3 Measurement datasets

##### Elements of a measurement dataset

A complete measurement dataset consists of:

- Consecutive number (is automatically assigned by the photometer)
- Date/time
- Identification (e.g. ID or "AutoStore")
- User name
- Measured parameter, e.g. method number, dilution, wavelength (depending on the measuring mode)
- Measured value with unit and, if necessary, citation form

##### Operations with measurement datasets

Measurement datasets can be

- stored (see Section 4.11.4)
- displayed and printed (see Section 4.11.6)
- filtered, i.e. selected or hidden based on certain criteria (see Section 4.11.7 and Section 4.11.8)
- deleted (see Section 4.11.9).

##### When the memory is full

You can erase measurement datasets (see Section 4.11.9), or overwrite the oldest dataset with the next storing procedure. A security prompt appears

before a dataset is overwritten. To backup the measurement data, you can transmit the measurement datasets from the measurement data memory to the internal DataB folder or a USB memory device connected to the USB-A connection and archive them further from there (see Section 4.12.3).

#### 4.11.4 Saving measurement datasets manually

After each measurement, you can store the measurement data manually with the **<STORE>** key. It is stored in the measurement data memory. The memory symbol  in the header indicates that the measurement data displayed on the screen is ready to be stored. In addition, with the measurement modes *Concentration*, *Absorbance / % Transmission* and *Special / Multi wavelengths* you have the opportunity to store all new measurement values automatically at the time of measurement (*AutoStore*, see Section 4.11.5).

#### Storing with identification (ID)

When storing manually, an input field for the identification (ID) appears after pressing the **<STORE>** key. Here you can enter an individual combination of alphanumeric characters for later easier identification of the measurement datasets. 30 digits are available for this.

The following measurement data are stored in the measured value memory automatically (see Section 4.11.5) or manually (with the **<STORE>** key, see Section 4.11.4):

- Concentration
- Multi wavelength
- Absorbance / % Transmission

The data stored in the measured value memory can be filtered with filter criteria and then exported to the PC-readable \*.csv format.

The photometer automatically offers a file name during the storage procedure.

#### Example: Saving data from the measured value memory

```
<HOME>
Concentration,
Absorbance / % Transmission,
Special / Multi wavelengths
├─ [Setup]
│   └─ Measurement data
│       memory
```

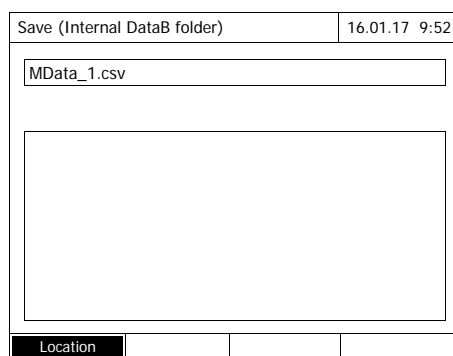

1 If necessary, set the filter criteria with [Setup].

2 Open the save dialog with **<STORE>**.

The photometer automatically proposes the location *Internal DataB folder* and a file name.

3 If necessary, change the location with [Location] (*USB memory*).

4 If necessary, change the proposed file name.

5 Save the measurement data with **<START-ENTER>**.

The data are stored.

If the photometer (*Internal DataB folder*) is selected as the location, the data can then be copied to a USB memory device (see Section 4.12.1).

#### 4.11.5 Saving measurement datasets automatically

For the measurement modes *Concentration*, *Absorbance / % Transmission* and *Special / Multi wavelengths* you can document each measurement value automatically (*AutoStore*). The *AutoStore* function is active in the default condition.

All automatically stored measurement datasets are given the ID "AutoStore". The "AutoStore" ID is overwritten if the same measured value is manually stored afterwards (**<STORE>**).

This ensures that every measurement dataset is stored in the data memory only once.

#### Activating or deactivating the *AutoStore* function

Activate or deactivate the *AutoStore* function as follows:



```

<HOME>
Concentration,
Absorbance / % Transmission,
Special / Multi wavelengths
├─ [Setup]
│   └─ Measurement data
│       memory
└─ Setup

```

The available functions are displayed.

- 1 Select and confirm *AutoStore*.  
The *AutoStore* function is active (✓) or inactive (no checkmark).
- 2 If required, give the automatically stored measured values and ID with the menu item *AutoStoreID*.
- 3 If the menu item *Increment AutoStoreID* is selected (✓), the ID of the automatically stored measured values is given a consecutive number.



The setting *AutoStore* works across the measurement modes *Concentration*, *Absorbance / % Transmission* and *Special / Multi wavelengths*.

#### 4.11.6 Displaying measurement data memory

Depending on the operating situation, you can recall the measured value memory as follows:

From the main menu

```

<HOME>
[Setup],
├─ Measurement data memory

```

**From a measuring mode**

Concentration,  
Absorbance / % Transmission,  
Special / Multi wavelengths

- └ [Setup]
- └ Measurement data memory

Each of these options indicates the contents of the measurement data memory as a list as follows.

Measurement data memory			16.01.17 9:52
15.01.17 14:00	3.50 mg/l Ni	Administrator	AutoStore
15.01.17 14:05	3.64 mg/l Ni	Administrator	AutoStore
15.01.17 14:10	3.69 mg/l Ni	Administrator	AutoStore
15.01.17 14:15	3.72 mg/l Ni	Administrator	AutoStore
15.01.17 14:20	3.72 mg/l Ni	Administrator	AutoStore
15.01.17 14:25	3.75 mg/l Ni	Administrator	AutoStore
15.01.17 14:30	3.73 mg/l Ni	Administrator	AutoStore
15.01.17 14:35	3.80 mg/l Ni	Administrator	AutoStore
15.01.17 14:40	3.78 mg/l Ni	Administrator	AutoStore
Filter ?			
Memory space usage: 9/			
Setup	Single value	Delete	

If there are more datasets available than can be displayed, the arrows ▲ and ▼ are displayed additionally.

*Filter* ✓ indicates that the filter settings are active. In this case, only those datasets are displayed that correspond to the selected filter criteria (see Section 4.11.7).

**Options**

Measurement datasets can be

- displayed in short form as a list or in details as individual values ([List] <-> [Single value])
- filtered (see Section 4.11.7 and Section 4.11.8)
- deleted (see Section 4.11.9).
- with **<STORE>**, you can store the entire displayed list as a \*.csv file in the internal DataB folder or on a USB memory device connected to the USB-A connection. The filter settings apply to the storing process. You can freely select the file name. Thus you can, e. g. store in a separate file and systematically archive measurement data of a certain period.
- with **<PRINT>**, the entire displayed list can be printed. The filter settings apply to the print process.

**4.11.7 Filtering measurement datasets**

The functions to display, delete and download stored measurement datasets refer to all stored measurement datasets that correspond to the specified filter criteria.

**Filter criteria**

The following filter criteria can be set:

- *Mode* (measured parameter)
- *User*
- *ID* (identification)
- *Date* (date from ... to ...)
- *Method* (for the measured parameters, *Concentration* and *Multi wavelength*)

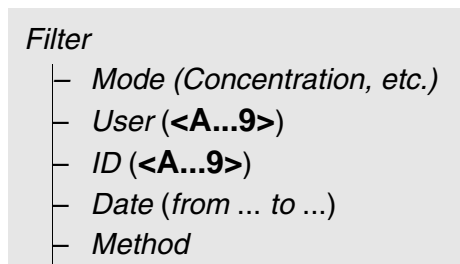
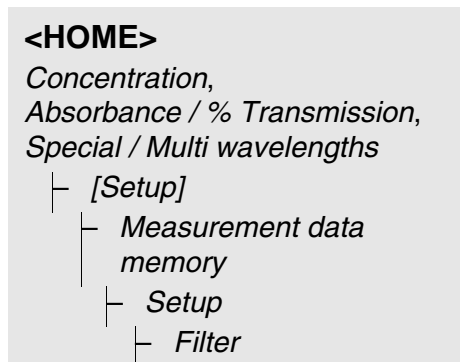

The filter setting menu is displayed.

- 1 Set the filter criteria.
- 2 If necessary, deactivate any selected filter criteria with *[Reset entry]*.
- 3 Confirm the filter selection with *[Apply]*.

Measurement data memory				16.01.17 9:52	
15.01.17	14:00	3.50 mg/l Ni	Administrator	AutoStore	
15.01.17	14:05	3.64 mg/l Ni	Administrator	AutoStore	
15.01.17	14:10	3.69 mg/l Ni	Administrator	AutoStore	
15.01.17	14:15	3.72 mg/l Ni	Administrator	AutoStore	
15.01.17	14:20	3.72 mg/l Ni	Administrator	AutoStore	
15.01.17	14:25	3.75 mg/l Ni	Administrator	AutoStore	
15.01.17	14:30	3.73 mg/l Ni	Administrator	AutoStore	
15.01.17	14:35	3.80 mg/l Ni	Administrator	AutoStore	
15.01.17	14:40	3.78 mg/l Ni	Administrator	AutoStore	

Filter ?  
Memory space usage: 9/

Setup	Single value	Delete
-------	--------------	--------

The *Measurement data memory* list is displayed.

The following information is displayed additionally:

- Current memory occupancy
- Active filter criteria (*Filter* ✓)



Alternatively, you can hide measurement datasets that meet the specified filter criteria with the *Selected values: invert selection* function (see Section 4.11.8).

### 4.11.8 Inverting filters

With the *Selected values: invert selection* function you can hide all measurement datasets that correspond to the specified criteria of the filter (see Section 4.11.7).



You can use this function to select and delete measurement datasets no longer used.

**<HOME>**  
*Concentration,  
 Absorbance / % Transmission,  
 Special / Multi wavelengths*

- | [Setup]
  - | Measurement data memory
    - | Setup
      - | Selected values: invert selection

Measurement data memory			16.01.17 9:52	
15.01.17	14:00	3.50 mg/l Ni	Administrator	AutoStore
15.01.17	14:05	3.64 mg/l Ni	Administrator	AutoStore
15.01.17	14:10	3.69 mg/l Ni	Administrator	AutoStore
15.01.17	14:15	3.72 mg/l Ni	Administrator	AutoStore
15.01.17	14:20	3.72 mg/l Ni	Administrator	AutoStore
15.01.17	14:25	3.75 mg/l Ni	Administrator	AutoStore
15.01.17	14:30	3.73 mg/l Ni	Administrator	AutoStore
15.01.17	14:35	3.80 mg/l Ni	Administrator	AutoStore
15.01.17	14:40	3.78 mg/l Ni	Administrator	AutoStore
Filter ?				
Memory space usage: 9/				
Setup	Single value	Delete		

The *Measurement data memory* list is displayed. All measurement datasets corresponding to the filter criteria are hidden.

#### 4.11.9 Erasing stored measurement datasets

If you no longer need any stored measurement datasets, you can erase them individually or altogether.

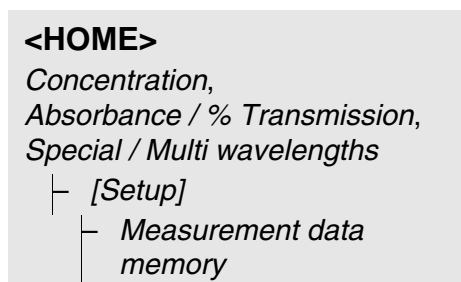

Measurement data memory			16.01.17 9:52
15.01.17 14:00	3.50 mg/l Ni	Administrator	AutoStore
15.01.17 14:05	3.64 mg/l Ni	Administrator	AutoStore
15.01.17 14:10	3.69 mg/l Ni	Administrator	AutoStore
15.01.17 14:15	3.72 mg/l Ni	Administrator	AutoStore
15.01.17 14:20	3.72 mg/l Ni	Administrator	AutoStore
15.01.17 14:25	3.75 mg/l Ni	Administrator	AutoStore
15.01.17 14:30	3.73 mg/l Ni	Administrator	AutoStore
15.01.17 14:35	3.80 mg/l Ni	Administrator	AutoStore
15.01.17 14:40	3.78 mg/l Ni	Administrator	AutoStore

Filter ?  
Memory space usage: 9/

Setup Single value Delete

The *Measurement data memory* list is displayed.

The filter settings used last are active.

#### Erasure functions

The following erasure functions are available.

- Erasing an individual measurement dataset
  - 1 Highlight a measurement dataset.
  - 2 Remove the highlighted measurement dataset with *[Delete]*.
- Delete all measurement datasets on the list displayed
  - 1 Open the settings menu with *[Setup]*.
  - 2 Select and confirm *Delete memory (selected values only)*.  
All measurement datasets corresponding to the current filter criteria are erased.

or
- Erasing all measurement datasets
  - 1 Select and confirm *Delete memory (all values)*.  
All measurement datasets are erased.

#### 4.11.10 Saving kinetics recordings, spectra and DeviceCheck files

After the following measurements, the *Save* dialog opens and prompts you to save the data in a \*.csv file:

- *Kinetics*
- *Spectrum*
- *MatrixCheck*/test of matrix influence

If the data are not saved in \*.csv format, they are lost when the measuring mode is terminated.



During a kinetic recording, the current measurement is always saved in the file, "KineticsBackup.csv" for safety reasons.

#### 4.11.11 Saving data as a pdf file

All data that can be printed (printer symbol on the display) can also be saved as a pdf file. The pdf file contains the data that are also output to a USB printer. Kinetic recordings and spectra are stored in the pdf file as a graphic.

Saving as a pdf file and printing is done with the **<PRINT>** key. Prerequisite is that pdf printing is set as the printer in the menu **<HOME>/General setup/Data transfer/Printer/Function of PRINT key**.

Subsequently, enter a file name and select the storage location (internally folder DataB or USB memory device).

## 4.12 Saving / exporting files

If you want to back up or process measurement data files outside the photometer, you can copy them to external media.



Please note the instructions for use of USB storage media (see Section 4.11.2).

### 4.12.1 Copying all measurement data files to a USB memory device

Even if no PC is directly connected to the photometer, you can very simply transfer all measurement data files from the photometer (*Internal DataB folder*) to a connected USB memory device.



When the data saving procedure is finished, a message appears.

- 1 Confirm the message with **<STORE>**.

All measurement data files from the photometer (*Internal DataB folder*) have been transferred to the USB memory device.

The complete folder structure from the photometer is created on the USB memory device. The individual measurement data files are stored in subfolders sorted by measurement data types:

Name	Änderungsdatum	Typ
CurrentMeasureDataStorage	01.02.2018 16:22	Dateiordner
Kinetics	01.02.2018 16:27	Dateiordner
MeasuredDataStorage	01.02.2018 16:23	Dateiordner
Spectrum	01.02.2018 16:21	Dateiordner

#### 4.12.2 Copying user-defined methods / profiles to a USB memory device

```
<HOME>
[Setup]
├ Exchange methods/profiles
  / Store to USB memory
  device
```

A list is displayed that includes all user-defined methods and profiles available on the photometer. All methods and profiles are checked off with a checkmark.

All methods and profiles checked off are saved.

- 1 If necessary, select individual methods/profiles with **<▲><▼>** and remove the checkmark with **<START-ENTER>**.

These methods/profiles will not be saved.

- 2 Start the save process with **[Store]**.

A message appears when the data have been saved.

- 3 Confirm the message with **<START-ENTER>**.

The save process is completed. The data are stored in the *Exchange\_Method\_Profile* folder on the USB memory device. The individual files with the methods/profiles are in subfolders.

Already existing files with identical names are overwritten without confirmation prompt.



### 4.12.3 Copying files to a PC

You can copy from the photometer to a PC the following data:

- Measured data
- Spectra
- Kinetic recordings
- DeviceCheck protocols
- User-defined methods
- Profiles

After saving measurement data in \*.csv or \*.pdf format, you can copy them to a PC. Measurement data in csv format can be directly imported to and processed in spreadsheets such as Microsoft® Excel®.



Depending on the country variant, some spreadsheet programs require a certain decimal separator for the correct import of numerical values (comma or point). The decimal separator can be selected in the following menu:

**<HOME>** -> *General setup* -> *Data transfer/Printer* -> *Decimal separator for csv-Files*.

Files containing measurement data can be copied to a PC in the following ways:

- By using a USB memory device as a temporary storage (see Section and Section 4.12.1). Subsequently, you can connect the USB memory device to a PC and read out the data.
- Via Ethernet (see Section 4.12.4 ACCESSING PHOTOMETER FILES VIA ETHERNET)

#### 4.12.4 Accessing photometer files via Ethernet

You can also connect the photometer directly to an Ethernet network with a suitable cable.

#### Ethernet settings

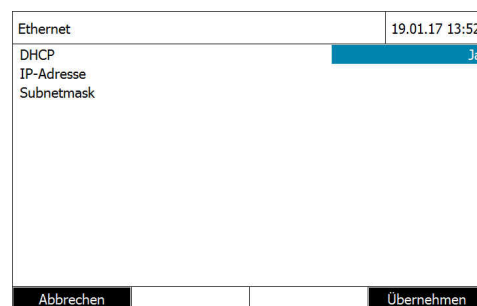
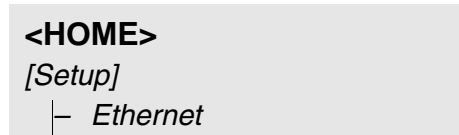

Make the settings for Ethernet:

With dynamic IP address (most frequent case):

- 1 Select *Yes* for DHCP .
- 2 Confirm the setting with *[Apply]*.
- 3 Connect the cable for the Ethernet connection to the photometer and an Ethernet outlet.
- 4 Wait for a moment, then open the Ethernet settings and check whether an IP address was assigned.

With a static IP address (rare case):

- 1 Select *No* for DHCP.
- 2 Enter the IP address and Subnet-Mask.
- 3 Connect the cable for the Ethernet connection to the photometer and an Ethernet outlet.



If you have questions concerning the setup of the Ethernet connection please contact your system administrator.

#### Access via FTP

Now you have access to the photometer via FTP (read access only). You can e.g. copy the files stored on the photometer to a PC.

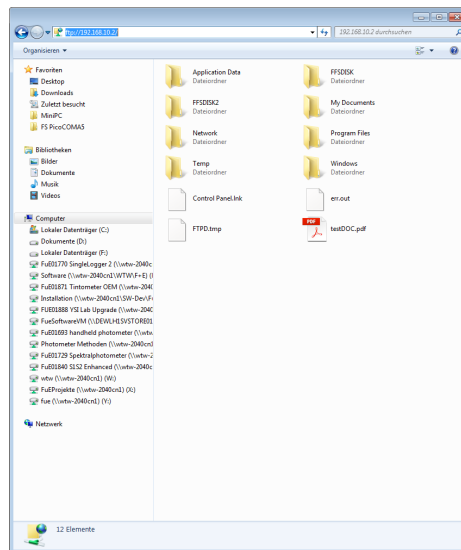

In Windows-Explorer on the PC, enter ftp://IP-address. The folders stored on the photometer are displayed.

The FFSDISK folder contains the relevant photometer data in the following sub-folders:

**FFSDISK\DataB:**

General measurement values, kinetics, spectrum, protocols.

**FFSDISK\UserMethods:**

User-defined methods (concentration)

**FFSDISK\MWLMETHODS :**

Special / Multi-wavelengths methods

**FFSDISK\KineticProfiles:**

Kinetic profiles

## 4.13 Importing files

On an XD 7x00 spectral photometer, you can import data that was created on the same or another XD 7x00 spectral photometer and saved on a USB storage medium or a PC.

You can import the following data:

- Spectra
- Kinetic recordings
- User-defined methods
- Profiles

### 4.13.1 Importing spectra or kinetic recordings from a USB memory device

You can import to the photometer any spectrum or kinetic recording by opening an externally stored spectrum or kinetic recording with the Open function of the photometer.

### 4.13.2 Importing methods / profiles from a USB memory device



When importing methods make sure that your photometer supports the wavelengths of the imported methods.

```
<HOME>
[Setup]
├ Exchange methods/profiles
│ / Import from USB memory
│ device
```

A list is displayed including all user-defined methods and profiles stored in the corresponding sub-folders of the Exchange directory on the USB memory device. All methods and profiles are checked off with a checkmark. All methods and profiles checked off are imported.

- 1 If necessary, select individual methods/profiles with **<▲><▼>** and remove the checkmark with **<START·ENTER>**.

These methods / profiles are excluded from importing.

- 2 Start the import with *[Import]*.

A confirmation prompt appears before any data on the photometer are overwritten.

A message appears when the data have been imported.

- 3 Confirm the message with **<START·ENTER>**.

The import is completed. The imported methods / profiles are available on the photometer.

### 4.14 Printing the data (USB)

#### 4.14.1 Printer and terminal programs

**Usable printers**

Data can be printed with standard printers (ink-jet or laser) connected to the USB-A interface. Suitable are the following PCL compatible printers.

- PCL 3, PCL 3 Enhanced
- PCL 5, PCL 5c, PCL 5e
- PCL 6 Standard

Unsuitable are printers using the following printer languages:

- PCL 3 GUI, PCL 6 Enhanced, PCL XL

The printer symbol  indicates that the display contents can be printed. To print, press **<PRINT>**.

**pdf file**

As an alternative, you can also output the print data to a pdf file.



In den following paragraphs, "Print" means:

- output to a USB printer
- output to a pdf file.

#### 4.14.2 Settings for data transmission

Settings are possible for the data transmission to a printer or PC.

**Decimal separators for CSV files**

For the output of CSV files you can select either a comma or a point as the decimal separator. The setting is made in the following menu:

**<HOME>** -> *General setup* -> *Data transfer/Printer* -> *Decimal separator for csv-Files* -> *Comma (12,34)* or *Point (12.34)*.

**Short and long version**

When printing measurement datasets, you can select a short or long version with different information contents. The setting is made in the following menu:

**<HOME>** -> *General setup* -> *Data transfer/Printer* -> *Data format (print)* -> *Short* or *Extended*.

**Printer**

Here you can set which function is assigned to the **<PRINT>** key:

- Output to a USB printer
- Output as pdf file

The setting is made in the following menu:

**<HOME>** -> *General setup* -> *Data transfer/Printer* -> *Function of PRINT key* -> *USB printer* or *PDF file*.

### 4.14.3 Printing measurement datasets

This section describes how to print measurement datasets of the measuring modes, *Concentration*, *Absorbance / % Transmission*, and *Special / Multi wavelengths*.

By means of sample printouts, the printed information is described below:

#### **Concentration**

```
21 05.06.07 14:05:41 844 mg/l CSB Supply
Administrator 0.005 02.06.07 11:02:13 2 PCheck: 9 MCheck: 14
```

Structure of the lines from left to right:

1st line:

*[Sequential no.] [Date] [Time] [Method name] [Measurement value] [Unit]  
[Citation form] [Dilution] [ID or "AutoStore"]*

2nd line (long version only):

*[User] [Reagent blank value] [Date of the blank value measurement]  
[Time of the blank value measurement] [Batch ID of the blank value measurement]  
[PCheck: stamp] [PCheck: protocol no.] [MCheck: stamp] [MCheck: protocol no.]*



Optional elements (e.g. dilution or ID) are output only if they were really used for measurement or storage.

#### **and Special / Multi wavelengths mode**

#### **Absorbance / % Transmission**

```
14 05.06.07 11:25:01 445 nm 0.609 Absorbance AutoStore
Administrator 0.133 02.06.07 09:59:01 PCheck: 9
```

#### **mode**

Structure of the lines from left to right:

1st line:

*[Sequential no.] [Date] [Time] [Wavelength] [Measured value]  
[Mode "Absorbance" or "Transmission"] [ID or "AutoStore"]*

2nd line (long version only):

*[User] [Value of reference absorbance] [Date of reference absorbance] [Time of reference absorbance] [PCheck: label] [PCheck: record no.]*



Optional elements (e.g. ID or reference absorbance) are output only if they were really used for measurement or storage.

#### 4.14.4 Printing spectra or Kinetics records



If you output a spectrum or kinetic record to a USB printer or as a pdf file, the current graphic display is shown on the display.



## 4.15 Quality assurance of the results (DeviceCheck)

### 4.15.1 General information

The target of the analytical quality assurance (DeviceCheck) is to secure correct and precise measurement results.



Settings for DeviceCheck checks are only available for users of the administrator user group.  
The DeviceCheck test can be performed by any registered user (see also Section 4.16.1).

The quality assurance measures can refer to two independent areas:

- PCheck: Check of the photometer
- MCheck: Test of the photometer and the method.  
This test includes the photometer, the test used, the accessories, and the user's method.

The monitoring includes a test run that must be repeated by the user successfully within a certain period (interval).



As delivered from the factory, this monitoring is not switched on.

### DeviceCheck in the measured value documentation

All measured values that are measured after a passed test within the DeviceCheck interval receive in the measured value documentation as addition the *Protocol ID*, via which the associated DeviceCheck test protocol can be identified. All measured values that are measured outside of the MCheck interval receive as addition the entry "expired" in the measured value documentation.

### 4.15.2 Checking of photometer (PCheck)

For the photometer test, at least one test standard set is required, e.g. the verification standard kit or a secondary standard kit with test certificate or another commonly-used test tool (e.g. filter).

The administrator specifies which test standard has to be used as the minimum requirement for the PCheck monitoring.

The extent of the monitoring can be enlarged with further test standards.



Settings for DeviceCheck checks are only available for users of the administrator user group.  
The DeviceCheck test can be performed by any registered user (see also Section 4.16.1).



Observe the shelf life of the test standards. The values in the photometer always have to be checked when a new package of test standard is used. If necessary, adjust the values at the photometer.

### Overview of the photometer monitoring

Photometer monitoring (PCheck) consists of the following parts:

- Configuring settings in the PCheck menu.
  - Switch on PCheck
  - Specify PCheck-Interval
  - Switch on/off device lock in case of missing or expired PCheck
  - Specify the scope of the PCheck monitoring by switching on or off the individual test standard
  - Enter the nominal values, tolerances and lot numbers for the individual test standards
- Carrying out the PCheck. The photometer compares the results with the nominal values while taking into account the tolerances.

The steps are described in detail below.

### PCheck Switching on

You switch on the PCheck monitoring on the *Mode* menu:

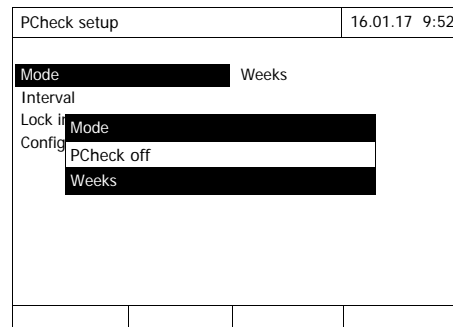
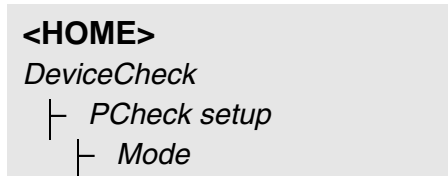

Select and confirm *Weeks*.

PCheck is switched on. The *Interval* setting indicates *Weeks* as the interval unit.

### Specifying PCheck-Interval

The PCheck Interval defines the interval between two PCheck checks. When an interval has expired, the following consequences become effective:

- Warning and loss of the PCheck labeling

- Locking of the photometer against all measurements (if activated).

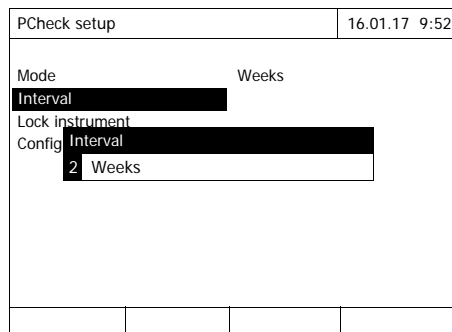
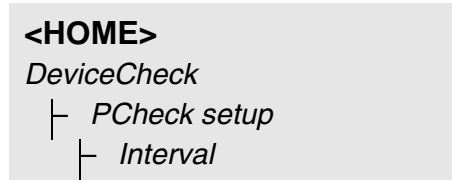

- 1 Enter a numeric value (2 to 52 weeks) (<0...9>) and confirm  
The *Interval* defined for the PCheck check is active.

### Configuring the lock of the photometer

Here you configure whether or not the photometer will be locked against all measurements if there is no valid PCheck check or the interval for the PCheck check has expired.

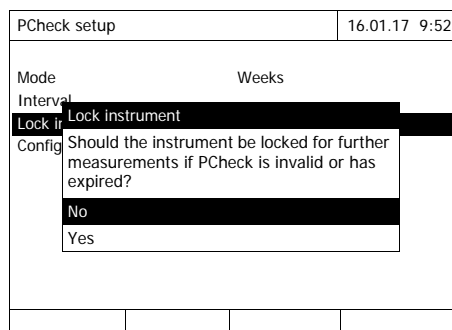
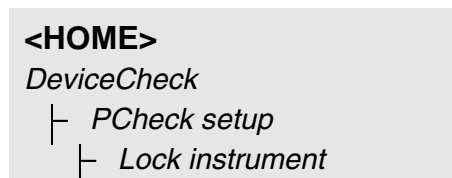

- 1 Select and confirm Yes.  
The photometer is locked against all measurements if the PCheck check is invalid or the PCheck interval has expired.

**Configuration of tests ...**

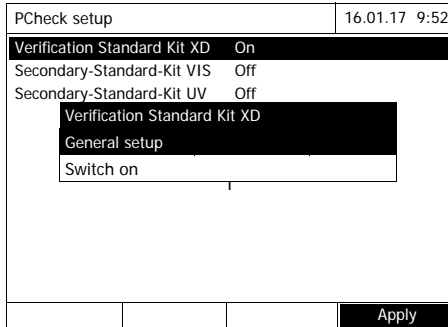
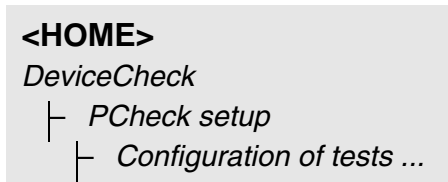

Verification Standard Kit XD		16.01.17 9:52
Lot number:	SOA1	
Use by	16.04.2019	
	Target value	Tolerance
430 L	0.205	± 0.020
430 LM	0.402	± 0.030
430 M	0.798	± 0.040
430 H	1.610	± 0.060
530 L	0.201	± 0.020
530 LM	0.397	± 0.030
530 M	0.808	± 0.040
530 H	1.591	± 0.060
		Apply

All configured test standards and test standard sets are listed.

- 1 Select and confirm a test standard or test standard set.
- 2 Adjust and confirm the extent of the monitoring with *Switch on* or *Switch off*.
- 3 Confirm the test standard (set) once again.
- 4 Switch to the adjustment of the nominal values and tolerances with *Setup*.

Example Verification-Standard-Kit XD:

- 5 Using **<▲><▼>** and **<<><>>**, select the *Lot number*, *Target value* or *Tolerance* entries and open them for editing with **<START-ENTER>**.
- 6 Enter and confirm the required value (**<0...9>**)
- 7 Accept all values with *[Apply]*.

**Carrying out the PCheck. (Example of Verification Standard Kit XD)**

The PCheck includes the test with all test standards that were switched on on the *DeviceCheck menu / PCheck setup / Configuration of tests ...* menu for PCheck (see Page 132).

At the beginning there is a barcode test with the two test cells BCT1 and BCT2 from the Verification Standard Kit XD. Then the test of the external barcode reader is done with a test barcode (included in the Verification Standard Kit XD).

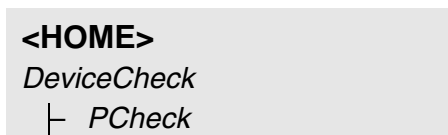

Checking the barcode reader	16.01.17 9:52
Please insert cell 'BCT1'	

Checking the barcode reader	16.01.17 9:53
Please read test barcode with external reader	

VERIFICATION STANDARD KIT XD 430 nm L	16.01.17 9:54
Reference measurement Please insert zero cell (distilled water).	

The photometer is ready for the zero adjustment.

- 1** Insert test cell BCT1.  
After reading the barcode, the request to insert the second test cell follows.
- 2** Insert test cell BCT2.  
After a successful barcode test comes the test of the external barcode reader.
- 3** Scan test barcode with the external barcode reader.

The photometer is ready for the zero adjustment.

- 4** Insert the zero cell.  
The cell is automatically recognized and the zero adjustment is started for all wavelengths.  
After successful zero adjustment, the photometer is ready for measurement for test standard 430 L from the Verification-Standard-Kit XD.

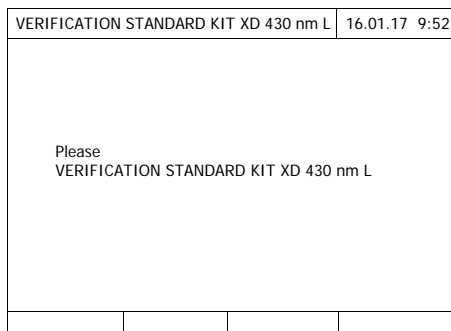

**5** Insert the cell.  
The cell is automatically recognized and the measurement started.

After measuring, the measurement result, Target value, Tolerance and an evaluation (OK or failed) are displayed.

The photometer offers to repeat the measurement if the check failed.

With successful measurement, the display shows the measurement of the next test standard from the Verification-Standard-Kit XD, e.g. 430 LM.

**6** Measure all test standards in the same way.  
After all test standards are successfully measured, the check is passed.

**Test record** A test record is displayed after the check. It can be printed and stored as a file (in the internal DataB folder or USB memory device at the USB-A connection, see Section 4.11.1).

Sample printout:

```

XD 700009130512 2.70-Tintometer-0.14 Administrator
PCheck OK
Protocol ID 9
Executed by: Administrator
Executed 16.01.2017
Valid until: 16.02.2017

Verific.-Standard-Kit XD OC479094 OK
430 L 0.205 +- 0.020 0.199
430 LM 0.402 +- 0.030 0.410
430 M 0.798 +- 0.040 0.801
430 H 1.610 +- 0.060 1.597
530 L 0.201 +- 0.020 0.203
.....
.....
(etc.)
    
```



Afterwards you can view the last PCheck test record under *PCheck info*.

### 4.15.3 Checking photometer and method (MCheck)

For the overall system monitoring, standard solutions with a defined analytic content are required (preferably certified ValidCheck<sup>®</sup> individual or multi-standards).



Settings for DeviceCheck checks are only available for users of the administrator user group.  
The DeviceCheck check can be performed by any registered user.

#### ValidCheck<sup>®</sup>

ValidCheck<sup>®</sup> Multistandards are ready-to-use multi-parameter standards, that is, they can be used for several test kits (methods).

In addition to these, ValidCheck<sup>®</sup> individual parameter standard solutions can also be used. These are already available diluted for the most common concentration or they can be set for dilution to further concentrations. The selected concentrations should be in the middle of the measurement range if possible.



For appropriate ValidCheck<sup>®</sup> standards, see our catalog or the Internet.

#### An overview of checking photometer and methods

The checking of photometer and method (MCheck) consists of the following parts:

- Configuring the general settings in the *MCheck setup* menu.
  - Select MCheck-interval unit (Weeks or Measurements)
- Select the method for which the MCheck should be switched on
- Configuring the method-specific settings in the *MCheck setup* menu.
  - Switching on the MCheck
  - Specify MCheck-Interval
  - Enter the nominal value, tolerance and designation (standard ID) for the test standard
- Carrying out the MCheck. To do this, select on the DeviceCheck menu MCheck and then the method for which MCheck should be carried out.

During the check the test is carried out with the standard solution as the sample while the other conditions are the same. The photometer compares the result with the nominal value while taking the tolerance into account.

The steps are described in detail below.

**General MCheck settings**

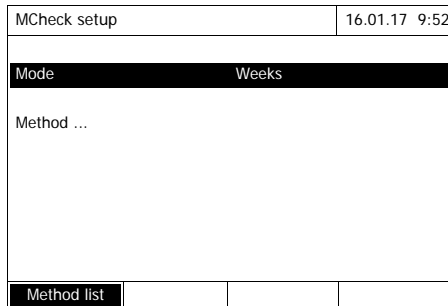
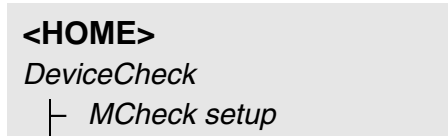

- 1 Select and confirm *Mode*.  
The *Mode* selection field pops up.
- 2 Select and confirm *Weeks* or *Measurements*.  
  
For all methods, the MCheckintervals are entered either in weeks or number of measurements.
- 3 Accept the general settings with *[Apply]*.



When the mode (*Weeks* or *Measurements*) is changed, all MCheck intervals are reset to the preset values.

**Switching on MCheck monitoring for a method**

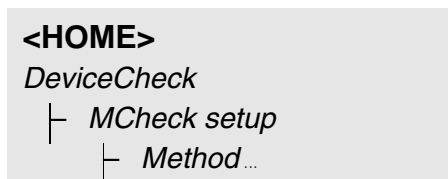



MCheck setup	16.01.17 9:52
Method	65: Ammonium LR TT
MCheck	MCheck on
Interval	12 Weeks
Citation form	NH <sub>4</sub> -N
Target value	2.00 mg/l NH <sub>4</sub> -N
Tolerance	0.20 mg/l NH <sub>4</sub> -N
Standard ID	
Method list	

- 1 Select a method (see Section 4.5.2).
- 2 Select and confirm *MCheck setup*.
- 3 Select and confirm *MCheck on*.  
MCheck is active for this method.

### Specifying MCheck-Interval, nominal value and tolerance

The MCheck Interval defines the interval between two MCheck checks. When an interval has expired, the following consequences become effective:

- Warning and loss of the MCheck labeling

Setting range:

1 to 12 weeks (default: 12 weeks) or

1 to 10000 measurements (default: 200 measurements)



The unit of the MCheck interval (Weeks or Measurements) is defined in the line, *Mode* (see Page 136).

MCheck setup	16.01.17 9:52
Method	
MCheck	MCheck on
Interval	12 Weeks
Target value	2.00 mg/l NH <sub>4</sub> -N
Tolerance	0.20 mg/l NH <sub>4</sub> -N
Standard ID	
Method list	

- 4 Select the *Interval* and enter the MCheck interval.
- 5 If necessary, adjust the values for *Target value* and *Tolerance*.
- 6 Optional: Select *Standard ID* and enter a designation. The designation is recorded in the MCheck documentation.

Repeat steps 1 to 8 if you want to configure further tests for MCheck.

### Carrying out the MCheck for a method

```
<HOME>
DeviceCheck
├─ MCheck
```

MCheck check	16.01.17 9:52
[ZERO 15.01.17 11:11]	
Target value	2.00 ± 0.20 mg/l
To start measurement, insert cell or press <START/ENTER>	
65: Ammonium LR TT 16 mm	NH <sub>4</sub> -N 0.02 - 2.50 mg/l
	Citation form    Unit

- 1 Via the DeviceCheck menu, select the MCheck test and then the method to be tested.
- 2 Carry out the check like a normal measurement (see section 4.5.1 to 4.5.2).
- 3 Insert a cell or Start the measurement with **<START-ENTER>**.

After the measurement is completed, the result and its evaluation are displayed.

If the check failed, it is possible to repeat the measurement.

If the check was successful, the *MCheck* function is finished.

**Test record**

A test record is displayed after the check. It can be printed and stored as a file (in the internal DataB folder or USB memory device at the USB-A connection, see Section 4.11.1).

Sample printout:

XD 700009130512 2.70-Tintometer-0.14 Administrator	
MCheck	OK
Protocol ID	32
Executed by:	Administrator
Executed	16.01.2017
Valid until:	13.03.2017
Method	65 NH <sub>4</sub> -N
Standard ID	VC 48201425
Target value	2.00 +- 0.20 mg/l
Measured value	2.14 mg/l



Later you can view the last test records for all MCheckmethods monitored with MCheck under *MCheck info*.

#### 4.15.4 Checking the sample for matrix influence (SCheck)

The *SCheck* is used to check if the photometric determination is disturbed by other substances present in the sample (sample matrix). The SCheck is done through spiking.

The ValidCheck<sup>®</sup> multi-standards include, in addition to a normal, also a more concentrated standard solution for spiking the sample. Since its parameters are already stored in the photometer, the execution of the test for the sample matrix is simplified. The SCheck can be carried out immediately. The volumes required for the sample and standards are displayed on the screen. The SCheck is then carried out with a single spike.

For the SCheck with individual standard, you can insert one or two spikes yourself depending on the measured value and measurement range end.



With activated user management, only users of the user group *Administrator* may change the settings for DeviceCheck tests. The DeviceCheck check can be performed by any registered user.

#### SCheck through spiking

For the SCheck by spiking, the photometric determination is repeated after a defined amount of analyte, which should be determined again, has been added to the test sample in the form of standard solutions.

From the added quantity of analyte (spiking), the nominal value for the determination is calculated under the assumption that there are no disturbing influences in the sample matrix. After the photometric determination the measured value is compared to the nominal value expected and the recovery rate is calculated. A matrix disturbance is likely if the recovery rate is less than 85 % or more than 115 %.

#### Practical instructions

- After evaluation of the measurement value of the sample, the photometer proposes a spiking for the SCheck with suitable volumes of sample and standard.  
You can change the suggested values of the volumes for the sample and standard. The photometer checks your entries and informs you of errors (e.g. if a nominal value is outside the measuring range of the test). The associated concentrated nominal value is displayed for each spiking.
- To be able to reliably recognize matrix effects by spiking, the volume increase after spiking should be small.
- You can carry out the SCheck with up to two measurements with different spiking volumes.
- Prepare all measurement solutions in parallel at the beginning of the measurements.

**SCheck in overview**

The SCheck consists of the following parts:

- Configuring settings in the SCheck setup menu.
  - Specifying the maximum deviation from the nominal value after spiking (factory setting: 15%)
- Carrying out the SCheck

**Specifying the maximum deviation from the nominal value**

The assessment of the recovery rate is determined with the maximum deviation from the nominal value. The assessment of the recovery rate is displayed next to the recovery rate after the check has been carried out.

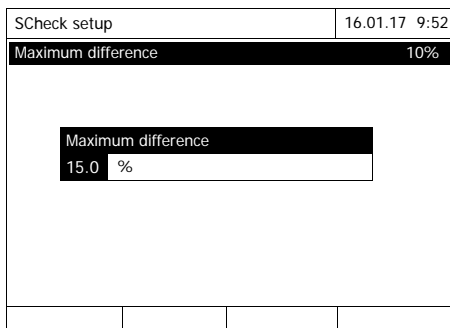
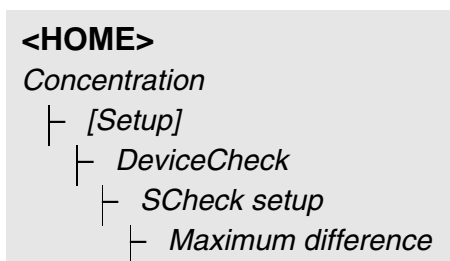

- 1 Enter and confirm a numerical value.  
The setting is active.
- 2 Exit the menu with <ESC>.

**Carrying out the S-Check .**

- 1 Measuring the original sample (without spiking) (see Section 4.5.1 to 4.5.2).

Concentration		16.01.17 9:52
45 mg/l		
130:(443 nm)	CSB	
16 mm	3 - 150 mg/l	
Setup	Method list	Citation form Unit

- 2 The measured value is displayed.
- 3 Open the settings menu with *[Setup]*.
- 4 Select and confirm *DeviceCheck*.
- 5 If necessary, check the settings in the menu, *SCheck setup*.
- 6 Select and confirm *SCheck setup*.  
The display for the SCheck opens.

SCheck (Spike)		16.01.17 9:52
Method	130	
Sample concentration	45 mg/ICSB	
Standard ID	0	
Standard concentration	0 mg/ICSB	
Sample [ml]	Standard [ml]	Target value [mg/l]
10	0	45
10	0	45
		Delete Next

If the spiking proposed by the photometer with the standard values of the ValidCheck multi-standard spiking solution causes an exceeding of the measurement range, these proposed values must be changed accordingly or the sample must be diluted and should be measured again.



The following description shows the flow for the SCheck through spiking.

SCheck (Spike)		16.01.17 9:52
Method	130	
Sample concentration	45 mg/ICSB	
Standard ID	48399612	
Standard concentration	200 mg/ICSB	
Sample [ml]	Standard [ml]	Target value [mg/l]
10	0.5	52.4
10	1	59.1
		Delete Next

- 7 In the *Standard ID* input field, select the simplified SCheck for a pre-parameterized ValidCheck<sup>®</sup> standard solution or enter a designation for another standard solution used.  
With selection of a ValidCheck<sup>®</sup>, no additional inputs are required (continue with step 10).
- 8 Enter the concentration of the used standard solution in the *Standard concentration* entry field.

**9** Enter the volumes of sample and standard of the individual test sample solutions in the columns, *Sample [ml]* and *Standard [ml]*. The nominal value is calculated after each entry.

- Use *[Delete]* to remove a measurement.

Note that all nominal values have to be within the measuring range of the test.

**10** Use *[Next]* to apply all entries on the page and move to the next page. The entries are checked by the photometer.

The photometer is ready to carry out the measurements.

SCheck (Spike)				16.01.17 9:52
Method		130		
Sample concentration		45 mg/ICSB		
Sample [ml]	Standard [ml]	Target value [mg/l]	nominal [mg/l]	
10	0.5	52.4	58	
10	1	59.1		
Back	Measureme		Complete	

**Carrying out measurements**

According to the program, the samples are measured top down. You can, however, select the samples yourself and thus change the order with *<▲><▼>*.

**11** Use *[Measurement]* to proceed to the measurement of the (first) sample.

The measurement display is shown.

**12** Insert the cell with the respective sample.

The sample is measured.

SCheck		16.01.17 9:52
Method		130
Sample concentration		45 mg/ICSB
Sample		10 ml
Standard		0.5 ml
To start measurement, insert cell or press <START/ENTER>		
16 mm		
Back		

SCheck					16.01.17 9:52
Method		130			
Sample concentration		45 mg/ICSB			
Sample [ml]	Standard [ml]	Target value [mg/l]	nominal [mg/l]		
10	0.5	52.4	51.1	97 %	✓
10	1	59.1			
Back		Measureme		Complete	

After the measurement, the recovery rate is displayed in the right table column.

The assessment of the recovery rate is displayed next to the recovery rate (✓ or ✗).

The criteria for the assessment are determined in the menu, *SCheck setup / Maximum difference*.

**13** If necessary, repeat steps 11 and 12 for the second sample.

**14** Complete the SCheck with [*Complete*].

The *Save* dialog box pops up.

**15** If necessary, change the storage location with [*Location*]:  
*Internal DataB folder*.  
Exchange folder on the instrument or  
*USB memory*:  
connected USB storage medium on the USB-A connection.

**16** If necessary, change the file name.

**17** Use **<START-ENTER>** to save the file.

The display changes back to the measured value view of the original sample without spiking.

The display shows the status indicator [SC]. A SCheck was carried out for this measured value.

Concentration		16.01.17 9:52
		[SC]
45		mg/l
130 (445 nm)	CSB	
16 mm	3 - 150 mg/l	
Setup	Method list	Citation form Unit

## Test record

The result of the SCheck is displayed in a test record. You can print this record and save it as a file.

To save the file on the photometer, select *Internal DataB folder* as the location. To save the file to an external USB memory device connected to the USB-A connection, select *USB memory* as the location (see Section 4.11.1).

Sample printout:

XD 700009130512 2.71-Tintometer-0.14 Administrator  
SCheck OK  
Protocol ID 7  
Method 130 CSB LR  
Sample concentration 45 mg/l CSB  
Standard ID 48399612  
Standard concentration 200 mg/l CSB

Sample ml	Standard ml	Target value mg/l	Actual value mg/l	
10	0.5	52.4	51	97% OK
10	1	59.1	57	92% OK



## 4.16 User management

The functions of the user management are only available for users of the user group, *Administrator*.

An administrator can

- activate or deactivate the user management for the meter
- create, change or delete individual user accounts.

### 4.16.1 User levels and user rights

The XD 7000 allows the management of up to 100 users. Every user is member of a user group with defined user rights.

#### User groups

There are three hierarchical user groups:

- *Administrator* (top level)
- *User* (user account registered by the administrator)
- *Guest* (user without user account)

Administrators and users log in to the photometer with their user name and password. Guests can optionally enter a name for their login. Thus, documented measured values can later be assigned to the user.

#### User rights in detail

Action	Administrator	User	Guest
Select methods	✓	✓	✓
Carry out measurements	✓	✓	✓
Store measurement data	✓	✓	✓
Check photometer (PCheck)	✓	✓	⊘
Check photometer (MCheck)	✓	✓	⊘
PCheck measured value labeling	✓	✓	✓
measured value labelingMCheck	✓	✓	⊘
Edit user-defined methods	✓	✓	⊘
Exchanging methods / profiles	✓	⊘	⊘
Change DeviceCheck settings	✓	⊘	⊘
Clear the memory	✓	⊘	⊘
Set the date and time	✓	⊘	⊘
Administrate users	✓	⊘	⊘
Reset photometer settings	✓	⊘	⊘
Carry out software update	✓	⊘	⊘



You can also switch off the user management and reactivate it as necessary. To do so, you need administrator rights. If the user management is switched off, the user name and password do not have to be entered. Each user has full rights.

### 4.16.2 Activating or deactivating the User management function

Each user can activate the user management function.

If the function is deactivated, each user has administrator rights.

Only members of the user group, administrator can deactivate the user management function.

If the function is active, each user has to log in to the photometer. After the login, the user has certain rights depending on the user group.

#### Activating the user management function

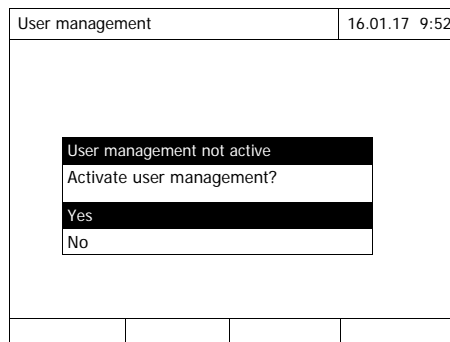
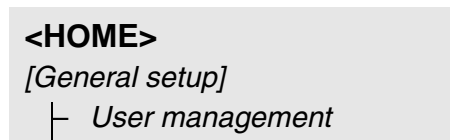

1 Select and confirm Yes.

The user management function is active.

Activating the user management creates an administrator user account. The user name is "Administrator". The preset password is "admin". Change this password as soon as possible.

#### Deactivating the user management function

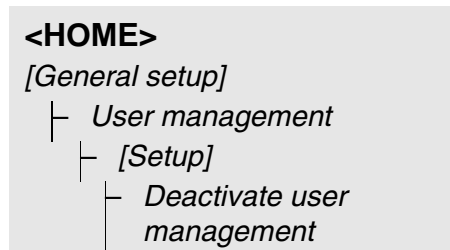

The user management function is inactive.

Each user has administrator rights.



If the user management is deactivated by a user of the *Administrator* user group, all user accounts that were set up are lost. The password for the administrator is reset to "admin".

### 4.16.3 Creating, changing or deleting a user account

When the user management function is active, a user with administrator rights can administrate user accounts.

#### Creating a user account

During the creation of a user account, the *Name*, whether or not the user belongs to a *User group* and the *Password* are defined.

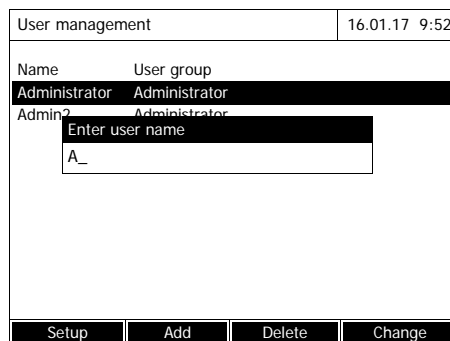
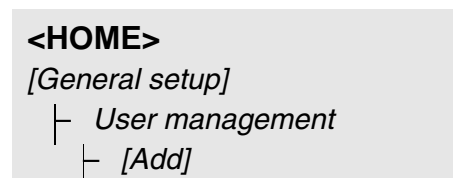

The input field for the new user name pops up.

- 1 Enter the user name (<A...9>) and confirm.  
The selection field for the user group (*Administrator / User*) pops up.
- 2 Select and confirm the user group.  
The input field for the password pops up.
- 3 Enter the password (<A...9>) and confirm.

The user account is created and appears in the list of user accounts.

#### Editing a user account

When a user account is changed, the *User group* and *Password* can be changed.

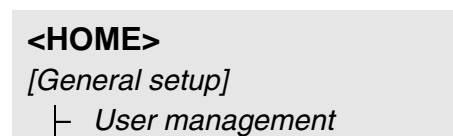

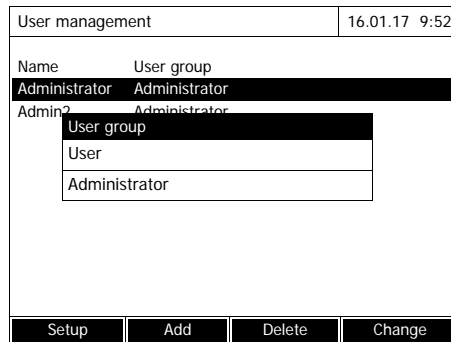

- 1 Select a user account.
- 2 Press *[Change]* to edit the user account.

The selection field for the user group (*Administrator / User*) pops up.

- 3 If necessary, select and confirm another user group.

The input field for the password pops up.

- 4 If necessary, enter (**<A...9>**) and confirm another password.

The user account is changed and appears in the list of user accounts.

**Deleting a user account**

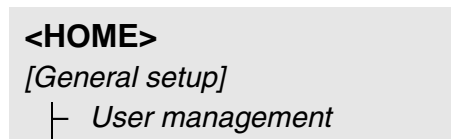

- 1 Select a user account.
- 2 Delete the user account with *[Delete]*.

A security prompt appears: *Confirm deletion ?*

- 3 Confirm the security prompt.

The user account is deleted.

#### 4.16.4 Login with active user management

To be able to always assign measurement data to a user, the administrator can activate the user management function. After doing so, the photometer can only be operated after login with a user name. Depending on the authorization class (administrator, user, guest), important settings are released for changes or locked.



The user management function is not active in the delivery condition of the XD 7000. Every user can carry out all functions.

Activating the user management creates an administrator user account. The user name is "Administrator". The preset password is "admin". Change this password as soon as possible.

Make sure to use the correct spelling (upper and lower case) of user name and password for the login.

After logging in to the *Administrator* group with a user name, you can create further users or administrators or switch off the user management function.

The *Login* window with the *Enter user name* prompt appears after the meter has been switched on and after a user has logged off.

In the following example, a user will log in with the user name, "Administrator".

Login		16.01.17 9:52	
<div style="border: 1px solid black; padding: 5px; margin: 10px auto; width: 80%;"> <p>Enter user name</p> <p>Administrator</p> </div>			
<div style="border: 1px solid black; width: 80%; margin: 10px auto; height: 20px;"></div>			
<div style="border: 1px solid black; width: 80%; margin: 10px auto; height: 20px;"></div>			

The photometer is switched on. The *Login* dialog is displayed.

- 1 Enter the user name (<A...9>) and confirm.

The input field for the password pops up.

If the user name is not known (or incorrectly spelled) it is possible to log in without a password as a guest with restricted rights (see Section 4.16.1).

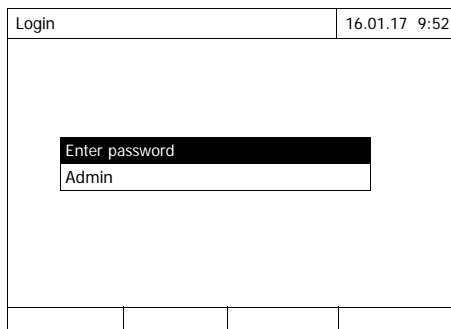

2 Enter the password (<A...9>) and confirm.

If the password is written correctly (note upper and lower case), the main menu *Home* opens up. The user name that was entered is displayed.

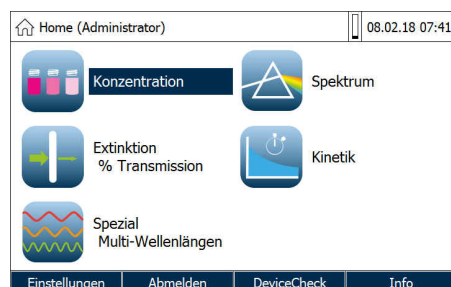

#### 4.16.5 Changing the password

The administrator sets up user accounts and assigns a password to each user account.

As soon as any user has successfully logged in with the password, they can change the password for their user accounts themselves.

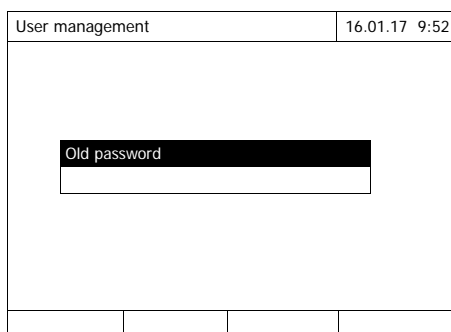
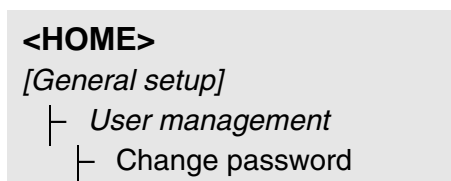

1 Enter and confirm the old password.

2 Enter and confirm the new password.

The password is changed.

### 4.17 Reset

You can reset (initialize) the measurement settings or all settings.



The *Reset* function is only available to users of the user group, Administrator.

You have the following options of resetting the photometer settings:

<ul style="list-style-type: none"> <li>● <i>Reset configuration</i></li> </ul>	<p>All settings except for the measurement data memory, user-defined methods and measured blank values are deleted.</p>
<ul style="list-style-type: none"> <li>● <i>Delivery condition</i></li> </ul>	<p>All settings (including measurement data memory and user-defined methods) are deleted and the photometer is reset to the delivery condition.</p>
<ul style="list-style-type: none"> <li>● <i>Internal DataB folder</i></li> </ul>	<p>The measurement data memory is erased. All other settings are retained.</p> <p>Save your measurement data (e.g. to a USB memory device) before erasing the internal data memory of the photometer.</p>

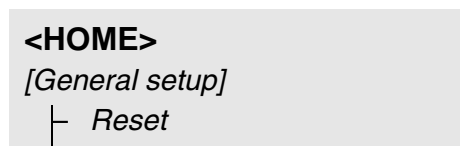

The menu where to select the reset type (*Delivery condition / Reset configuration*) is displayed.

- 1 Select and confirm the reset type. The reset is carried out.

### 4.18 Photometer information ([Info])

The following photometer information is displayed:

- Photometer designation
- Version number of the meter software/method data
- Hardware version
- Series number of the meter
- Registered user
- Hardware status (for service purposes)
- Memory status

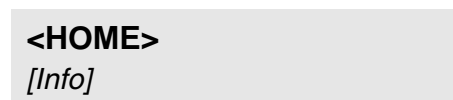

Info		16.01.17 9:52
Model designation:		XD 7000
Serial number:		15150001
Software/methods version:		2.70-Tintom.0.14
Build:		25.02.17 11:57
Hardware version:		0-1-0-22-50--
Hardware status:		FF 00000000
Lamp counter		12
System test		✓?
Filter test		✓?
Lamp test		✓?
Wavelength calibration		✓?
Free internal memory space		5046 KB
Registered user		?

The meter information and result of the self-test are displayed and can be printed.

### 4.19 Lamp counter

The photometer counts the operating hours of the lamp. The information on the operating hours of the lamp is given in the *Info* menu.



## 4.20 Software and methods update

The software and method update is used to continuously update your photometer.



If the user administration is activated, only users of the user group *Administrator* may carry out any software and method updates.

The update comprises

- the newest firmware (meter software)
- new or changed method data



User-defined data (such as settings, user-defined methods or measured data) are not changed by a software and methods update.

You can find the current software version on the Internet at [www.Tintometer.com](http://www.Tintometer.com).

The transfer to the photometer happens as follows:

- simply via a USB storage medium as intermediate storage (Section 4.20.1).

### 4.20.1 Software- and method update using a USB memory device

Store the new software required for the update on the USB memory device and connect it to the photometer.

#### Execution

- 1 Connect the USB memory device to the PC.
- 2 Unpack the contents of the downloaded exe or zip file with the complete folder structure in the main directory (top level) of the USB memory device.



Make sure the folder structure of the files is retained while the files are unpacked. If you use a program such as WinZip for unpacking, the option, "Nutze Ordernamen" or "Use Folder Names" must be set. Details are given in the documentation of the unpack program.

The "Update" folder must be on the top level of the USB memory device. The

Update folder contains several subfolders.

The following steps are carried out at the photometer.

- 3 Connect the USB memory device to the photometer.
- 4 Switch on the photometer if necessary.

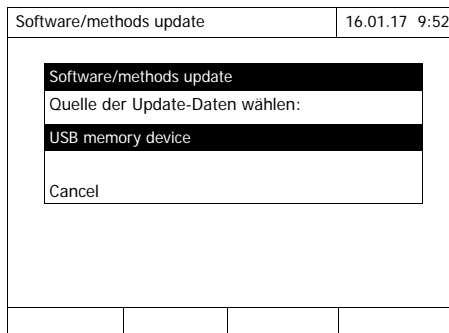
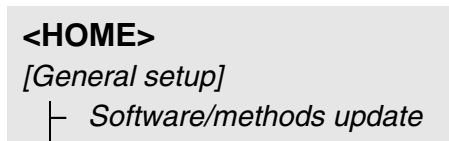

- 5 Using <▲><▼>, select *USB memory device* as the source and press <START-ENTER>.

The update process takes approx. five minutes.  
The photometer switches itself off and then on again.



If the update cannot be carried out, an error message is displayed.

Check whether the "Update" folder with its subfolders is stored on the USB memory device (top level).

If on the photometer there is not enough free memory capacity for the update, you can create memory capacity by erasing measurement data. Save your data to a USB memory device before erasing them on the photometer.

#### 4.20.2 Remote functions

The photometer has a programming interface for remote control. More detailed information on this is available on request from the manufacturer.

The photometer can also process a script file stored on a USB flash drive. This function is among the general settings of the photometer. More detailed information on the function and the requirements of the script file is available on request from the manufacturer.

## 5 Maintenance and cleaning

### 5.1 Replacing the lamp

#### Service life of the tungsten halogen lamp

The tungsten halogen lamp is a wear part with a certain average service life (see Chapter 7 TECHNICAL DATA). It has to be replaced if defective. The photometer has a service hour counter for the lamp module (see Section 4.19).

#### NOTE

*The replacement lamp is readily assembled as a lamp module and optically adjusted in the factory. Therefore, treat it with utmost care. Fingerprints on the glass will shorten the service life of the lamp. Do not touch the bulb of the new lamp module with your bare fingers. If you have touched the bulb inadvertently, carefully clean it with a clean cloth soaked in alcohol.*

#### Replacing the lamp module

The lamp module is behind a cover (aluminium sheet) on the rear panel of the photometer. Proceed as follows:



#### CAUTION

**The lamp becomes very hot during operation. Do not touch the hot lamp because it can cause burns! The lamp should cool down for approx. 10 minutes before it is exchanged.**

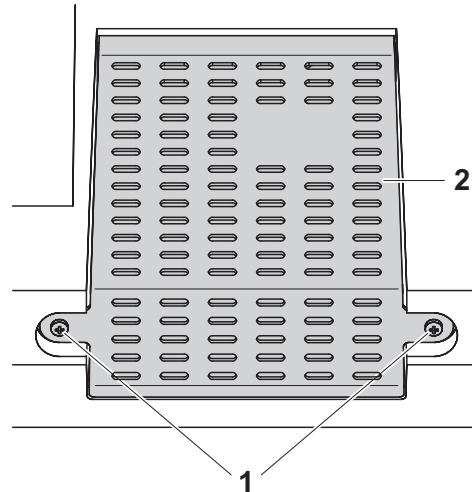

- 1 Switch off the photometer and disconnect it from the power supply.
- 2 Unscrew the two screws (1) and remove the lamp cover (2).

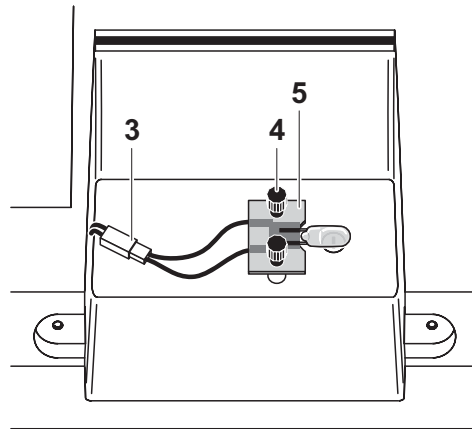

- 3 Disconnect the electrical plug connection (3). Disconnecting it may take a lot of effort.
- 4 Unscrew the two knurled-head screws (4) and remove the defective lamp module (5).
- 5 Fix the new lamp module with the knurled-head screws. When doing so, the metal-plated side of the PCB must point outward, i. e. toward the knurled-head screws.
- 6 Reconnect the electrical plug connection.
- 7 Fix the lamp cover.
- 8 Reset the service hour counter for the lamp module (see Section 4.17).



After recommissioning, carry out a new zero adjustment for all measurements.

## 5.2 Exchanging the buffer battery



### CAUTION

There is a risk of explosion if unsuitable batteries are used. Only use leakproof alkaline manganese batteries.



If you leave the photometer switched on during the exchange or insert the new batteries within a minute after taking out the old ones, the date and time are retained in the photometer.

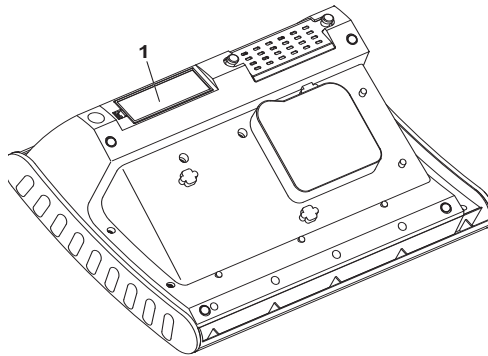

- 1** Turn the photometer upside down and place it on a soft surface.
- 2** Open the lid of the battery compartment (1).
- 3** Remove the old batteries from the battery compartment.
- 4** Insert the four new batteries in the battery compartment. Make sure that the poles of the batteries are in the correct position.
- 5** Close the lid of the battery compartment.

### **Disposal of batteries**

Dispose of the batteries at a suitable facility according to local legal requirements. It is illegal to dispose of the batteries with household refuse.

Within the European Union, the batteries are removed at a specialized treatment center at the instrument's end of life. The instruments are taken to one of those specialized treatment centers via the recycling system set up for this purpose.

### 5.3 Cleaning

Especially after a cell has broken or after a reagent accident, the photometer should immediately be cleaned (see also Section 6.1 ACTIONS IN THE CASE OF A BROKEN CELL).

#### NOTE

*The housing components are made out of synthetic materials (ABS, PMMA and PC). Thus, avoid contact with acetone, ethyl alcohol and similar detergents that contain solvents. Remove any splashes immediately.*

#### 5.3.1 Cleaning the enclosure

Clean the photometer enclosure as follows:

- If the housing surface is dirty, wipe it with a soft cloth and mild soapy water.
- Remove any chemicals splashes as soon as possible.
- For disinfection, you can use isopropanol for cleaning for a short time.

#### 5.3.2 Cleaning the cell shaft



If a cell has broken, the cell shaft has to be cleaned immediately. To do so, proceed as described in Section 6.1.

Normally, it is not required to clean the cell shaft routinely. Remove dust and slight contamination with a moist, lint free cloth. Use isopropanol briefly to remove persistent coatings (e.g. reagent remains). Especially clean the bottom parts of the lateral surfaces of the rectangular cell shaft where the light barriers for the automatic cell recognition are located.

### 5.3.3 Cleaning the detector lens

Normally, it is not required to clean the detector lens routinely. Cleaning the detector lens can be necessary in the following cases:

- If the lens is visibly smudged, e.g. after a cell has broken or after a reagent accident (see also Section 6.1 ACTIONS IN THE CASE OF A BROKEN CELL).
- If, due to environmental influences or reagent contamination, the photometer displays the message, *Wavelength calibration* during the self-test after being switched on (see Section 6.2)



If the lens is often smudged (error, *Wavelength calibration* during the self-test), check whether the correct operating conditions are observed. Follow the details in Section 3.2 for this purpose.

Proceed as follows to clean the detector lens:

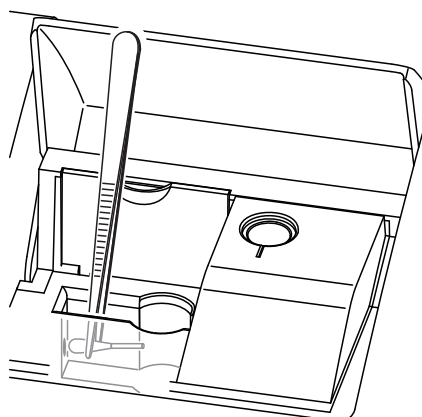

The detector lens is on the front left side of the rectangular cell shaft (pos. 1).

- 1 Switch off the photometer.
- 2 Cut off one end of a customary cotton swab (approx. 2 cm).
- 3 Grasp the cut-off end with the tip of a pair of tweezers or small pliers. Clean the lens with the dry head of the cotton swab. To do so, move the head from the center of the lens outward in circles. If there are persistent coatings, moisten the cotton swab with a little deionized water or isopropanol.



After recommissioning, carry out the photometer monitoring for all measurements (see Section 4.15.2 CHECKING OF PHOTOMETER (PCHECK)).

## 6 What to do if...

### 6.1 Actions in the case of a broken cell



#### WARNING

Cells can contain dangerous substances. If the contents are released, follow the safety instructions of the package insert. If necessary, take corresponding protective measures (protective goggles, protective gloves etc.).



#### CAUTION

Do not turn the photometer upside down or laterally to remove the liquid!

When doing so, the liquid could come into contact with electronic components and damage the photometer.

The photometer has a drain device through which the contents of a broken cell can drain off without causing any damage.

#### Proceeding after a cell has broken

- 1 Switch off the photometer and disconnect it from the power supply.
- 2 Let the liquid drain off into a suitable container and dispose of it properly according to the instructions of the reagent package.
- 3 Carefully remove all broken glass, e.g. with tweezers.
- 4 Carefully clean the cell shaft using a moist, lint-free cloth. If there are persistent coatings, use isopropanol for a short time. Especially clean the bottom parts of the lateral surfaces of the rectangular cell shaft where the light barriers for the automatic cell recognition are located.
- 5 Let the cell shaft dry.



After recommissioning, carry out the photometer monitoring for all measurements (see Section 4.15.2).

If, after recommissioning, an error occurs during the wavelength calibration, the detector lens is probably smudged. In this case, clean the lens according to Section 5.3.3 CLEANING THE DETECTOR LENS.



## 6.2 Error causes and remedies

<b>Instrument does not react to button press</b>	<b>Cause</b>	<b>Remedy</b>
	– Operating condition undefined or EMC load unallowed	– Processor reset: Press the <b>&lt;ON/OFF&gt;</b> and <b>&lt;ESC&gt;</b> key simultaneously.

<b>Audio signal on keystroke</b>	<b>Cause</b>	<b>Remedy</b>
	– The key does not have any function in the current operating state	– Press the appropriate key

<b>Measuring range exceeded or underrun</b>	<b>Cause</b>	<b>Remedy</b>
	– Measuring range or method not suitable	– Select method with suitable measuring range – Dilute the sample



In *Concentration* mode you can display the current absorbance value as an additional information (*[Setup]/Display absorbance*, see also Section 4.5.6).

<b>Self-test does not start. The instrument displays <i>Please remove cell</i></b>	<b>Cause</b>	<b>Remedy</b>
	– A cell is inserted in one of the cell shafts	– Remove the cell – Then press the <b>&lt;START-ENTER&gt;</b> key
	– A foreign object is inserted in one of the cell shafts	– Remove foreign object – Then press the <b>&lt;START-ENTER&gt;</b> key
	– Occasionally, the instrument carries out an automatic readjustment for the rectangular cell recognition. The informative message <i>Please remove cell</i> is displayed even when no cell is inserted.	– Press the <b>&lt;START-ENTER&gt;</b> key.

Cause	Remedy
– The cell shaft is contaminated	<ul style="list-style-type: none"> <li>– Clean the cell shaft (see Section 5.3.2 and Section 6.1)</li> <li>– Restart the instrument</li> <li>– If necessary, confirm the <i>Please remove cell</i> message with <b>&lt;START·ENTER&gt;</b>.</li> </ul>
– Instrument defective	– Please contact the service department.

### Obviously incorrect measured values

Cause	Remedy
– Cell contaminated	– Clean the cell
– Dilution set incorrectly	– Adjust dilution
– Selected method not suitable	– Select different method
– Zero measurement incorrect	– Perform zero measurement
– Blank value incorrect	– Remeasure the blank value
– Lamp module exchanged	– Reset the service hour counter for the lamp module (see Section 4.17).

### Fluctuating measured values

Cause	Remedy
– Cell shaft cover open	– Close the cell shaft cover

### Self test failed.

Cause	Remedy
– <i>System test</i> : Instrument defective	– Please contact the service department.
– <i>Filter test</i> : Instrument defective	– Please contact the service department.
<ul style="list-style-type: none"> <li>– <i>Lamp test</i>: <ul style="list-style-type: none"> <li>– If <u>no light</u> leaks out at the rear side of the photometer: Lamp defective</li> <li>– If light does leak out at the rear side of the photometer:</li> </ul> </li> </ul>	<ul style="list-style-type: none"> <li>– Change lamp (see Section 5.1)</li> <li>– Carry out a software update (see Section 4.20)</li> </ul>

	<p><b>Cause</b></p> <ul style="list-style-type: none"> <li>- <i>Wavelength calibration:</i> <ul style="list-style-type: none"> <li>- Foreign particle in the cell shaft</li> <li>- Lens smudged</li> </ul> </li> <li>- Instrument defective</li> </ul>	<p><b>Remedy</b></p> <ul style="list-style-type: none"> <li>- Remove foreign object</li> <li>- Clean the lens (see Section 5.3.3 or Section 6.1). If this happens repeatedly, check the operating conditions (see Section 3.2)</li> <li>- Please contact the service department.</li> </ul>
<p><b>Instrument measures immediately after scanning the barcode without pressing the &lt;START·ENTER&gt; button</b></p>	<p><b>Cause</b></p> <ul style="list-style-type: none"> <li>- Barcode reader set incorrectly</li> </ul>	<p><b>Remedy</b></p> <ul style="list-style-type: none"> <li>- Set the barcode reader so that after the barcode is scanned, no more suffix is transmitted via the USB interface (see operating manual for the barcode reader).</li> </ul>
<p><b>Connected printer does not print</b></p>	<p><b>Cause</b></p> <ul style="list-style-type: none"> <li>- Printer not suitable</li> </ul>	<p><b>Remedy</b></p> <ul style="list-style-type: none"> <li>- Connect a printer that can interpret the required printer control language (see Section 4.14.1 PRINTER AND TERMINAL PROGRAMS)</li> </ul>
<p><b>Data transmission to USB memory device does not work</b></p>	<p><b>Cause</b></p> <ul style="list-style-type: none"> <li>- Connected USB memory device was not recognized</li> <li>- The USB memory device has been formatted to a file system which is not supported, e. g. NTFS</li> </ul>	<p><b>Remedy</b></p> <ul style="list-style-type: none"> <li>- Use other USB memory device</li> <li>- Format the USB memory device to the FAT 32 file system</li> </ul>

## 7 Technical data

### 7.1 Measurement characteristics

<b>Measuring principle</b>	Spectrophotometer with reference beam technology	
<b>Light source</b>	Lamp type	Tungsten halogen lamp
	Average lifetime	approx. 1000 h
<b>Monochromator</b>	Type	Grating monochromator with step motor
	Wavelength range	320 - 1100 nm
	Max. scan speed	approx. 800 nm/min
	Wavelengths calibration	Automatic
	Accuracy	$\pm 1$ nm
	Reproducibility	$\pm 0,5$ nm (can be checked, e. g. with Holmium oxide filter)
	Resolution	1 nm
	Spectral band width	4 nm
<b>Photometric measurement</b>	Light sensor	Photo diode
	Measuring range	$A = -3.300$ to $A = +3.300$
	Linearity	$< 1$ % for $E \leq 2,000$ in the range from 340 to 900 nm
	Accuracy	$\pm 0.003 A$ for $A < 0.600$ $\pm 0.5$ % of the reading for $0.600 \leq A \leq 2.000$
	Reproducibility	$\pm 0.002$ at $A = 1.000$
	Resolution	$\Delta A = 0.001$
	Scattered light	$< \%$ Transmission at 340 and 408 nm
		* in the range from 330 nm to 1100nm

<b>Usable Cells</b>	Round cells 16 mm	<ul style="list-style-type: none"> <li>– Outer diameter: 16 mm</li> <li>– Inner diameter: 13.6 mm</li> <li>– Flat cell bottom</li> <li>– 13 mm with adapter</li> </ul>
	Round cells 24 mm	<ul style="list-style-type: none"> <li>– Outer diameter: 24 mm</li> <li>– Inner diameter: 21.5 mm</li> <li>– Flat cell bottom</li> </ul>
	Round cells 13 mm	13 mm with adapter
	Minimum filling level	20 mm
	Minimum filling volume	Round cell 16 mm: 4 ml Round cell 24 mm: 10 ml Rectangular cell, 10 mm: 2 ml Rectangular cell, 20 mm: 4 ml Rectangular cell, 50 mm: 10 ml
	Cell recognition	Automatic for most types

\* Depending on the wavelength range, different kinds of cells are suitable. Suitable are round cells, all rectangular cells of glass, quartz or plastic, whose side surfaces are frosted (see Section 8.1). Cells with clear or serrated lateral surfaces are not reliably recognized by the automatic cell recognition.  
 Especially with plastic single-use cells we recommend you test them for suitability prior to carrying out large-scale series of measurements.  
 For measurements in the UV range below 320 nm, glass cells and commercial PS plastic cells are not suitable; below 280 nm, commercial PMMA plastic cells are not suitable due to their transmission characteristics. Therefore, use quartz cells or tested single-use cells (plastic) for applications in the UV range.

## Measuring modes

- Concentration
  - Measurement with permanently programmed methods,
  - Automatic method selection for test sets with barcode and external barcode reader
  - Program support for the creation of additional user-defined methods (max. 100)
  - Citation forms and units method dependent
  - Display of the absorbance value can be added
  - Method data update possible via Internet

**Measuring modes**

- Absorbance / % Transmission
  - Measurement against own reference absorbance value possible
- Multi wavelengths
  - Freely definable calculations from absorbance values at up to 10 different wavelengths
  - Calculations can be stored as methods (max. 499)
- Spectrum
  - Absorbance or % transmission mode
  - Limits freely selectable within the wavelength range
  - Increment: 1 nm
  - Recording duration for the complete wavelength range: < 7 min
  - Settings can be stored as profiles (max. 20)
  - Evaluation functions: Cursor scanning, zoom, min./max. recognition, peak area determination, derivation, smoothing, multiplication by constants, addition of constants, addition and subtraction of spectra, formation of the quotient of two spectra
- Kinetics
  - Absorbance or % transmission mode
  - Minimal adjustable scan interval: 1 s (if the absorbance of the test sample is high, the scan interval is extended due to the longer duration of the individual measurements)
  - Settings can be stored as profiles (max. 20)
  - Evaluation functions: Cursor scanning, zoom, min./max. determination, slope calculation (for an interval or total), enzymatic activity

**7.2 Measured value documentation and quality assurance**

**Memory for measurement values**

Memory capacity	<ul style="list-style-type: none"> <li>– 5000 single measured values from the measuring modes, concentration, absorbance / % transmission and multi wavelengths</li> <li>– 40 MByte internal memory, sufficient for approx. 500 spectra and 400 kinetic curves (sample values based on the following assumptions: All spectra over a wavelength range of 600 nm and all kinetic curves with 150 single values each)</li> </ul>
-----------------	--

	Output options	USB memory device, printer, PC
	File formats	ASCII, *.csv
<b>Monitoring functions</b>	PCheck	Check of the photometer
	MCheck	Check of the total system
	SCheck	Check of the sample matrix
<b>User management</b>	Can be switched off	yes
	User accounts	3 hierarchical levels (administrator, user, guest)
	Password protection	for administrators and users

### 7.3 General meter data

<b>Dimensions</b>	422 x 195 x 323 mm (width x height x depth)	
<b>Weight</b>	approx. 4.5 kg (without plug-in power supply)	
<b>Housing type of protection</b>	IP 30	
<b>Electrical protective class</b>	III	
<b>Test certificates</b>	CE	
<b>Permissible environmental conditions</b>	Temperature	Operation: +10 °C to + 35 °C (41 °F to 95 °F) Storage: -25 °C to +65 °C (-13 °F to 268 °F)
	Humidity	Yearly mean: ≤ 75 % 30 days/year: 95 % Other days: 85 %
	Climatic class	2
<b>Power supply</b>	Power pack	Type: EDACPOWER EA1036R / EA1024PR Input: 100 - 240 V ~ / 50 - 60 Hz / 1 A Output: 12 V = / 3 A (compliant with eco design directive 2009/125/EG, EuP step 2)

<b>Applied directives and standards</b>	EMC	<p>EC directive 2004/108/EC                      EN 61326-1</p> <ul style="list-style-type: none"> <li>– Interference emission: Class B</li> <li>– Interference immunity: IEC 61000-4-3                          Tolerance extension: 0.008 E</li> </ul> <p>FCC Class A</p>
	Meter safety	<p>EC directive 2006/95/EC                      EN 61010-1</p>
	Climatic class	<p>VDI/VDE 3540</p>
	IP protection class	<p>EN 60529</p>
<b>Communication interfaces</b>	Ethernet	<p>RJ45</p>
	USB	<ul style="list-style-type: none"> <li>– 1 x USB-A (for printer, USB memory devices, keyboard or bar code reader)</li> <li>– 1 x USB-B (for PC)</li> </ul>
Other features	<ul style="list-style-type: none"> <li>● Drain for spilled cell contents</li> <li>● Photometer software update and method data update possible via Internet</li> </ul>	



**Available languages**

- German
- English
- French
- Spanish
- Italian
- Bulgarian/Български
- Czech
- Simplified Chinese/ 中文
- Traditional Chinese/ 繁體中文
- Dansk
- Dutch
- Greek/Ελληνικά
- Indonesian/Indonesia
- Japanese/ 日本語
- Korean
- Magyar
- Malay/Melayu
- Macedonian/Македонски
- Norsk
- Polski
- Português
- Romanian/Română
- Russian/Русский
- Serbian/Srpski
- Slovenščina
- Svenska
- Thai/ ภาษาไทย
- Turkish/Türkçe
- Vietnamese/Việt

## 8 Accessories and options

### 8.1 Accessories

<b>Cells</b>	<b>Description</b>	<b>Order no.</b>
	24 mm round cell with lid, 5 pcs.	197629
	Rectangular cell, 10 mm	601040
	Rectangular cell, 20 mm	601050
	Rectangular cell, 50 mm	601070
	Rectangular cell, quartz, 10 mm	661130
	Rectangular cell, quartz, 20 mm	661140
	Rectangular cell, quartz, 50 mm	661160
	Cleaning cloth for cells	197635
<b>Replacement lamp</b>	<b>Description</b>	<b>Order no.</b>
	Halogen lamp module for XD 7000	71310000
<b>Cable for portable use</b>	<b>Description</b>	<b>Order no.</b>
	12 V connector cable	71310020
<b>Other accessories</b>	<b>Description</b>	<b>Order no.</b>
	Barcode hand scanner	71310030
	Power supply station	711050

## 8.2 Test equipment

Test equipment	Description	Model	Order no.
	Test equipment for PCheck	Verification Standard Kit	215663
	Secondary standard kit VIS with calibration certificate		711160
	Secondary standard kit UV with calibration certificate		711161
	Zero cell 16 mm		215661
	Zero cell 24 mm		215662
	Test equipment for MCheck	ValidCheck DW Anions	48399312
		ValidCheck DW Metals	48399212
		ValidCheck WW Influent	48399712
		ValidCheck WW Effluent	48399612



Additional ValidCheck standard solutions for checking methods are available.

## 8.3 Optional equipment

You can get a USB-PC keyboard at a dealer's.

## 8.4 Connection cable:

**PC** You can connect a PC to the XD 7000 in one of the following ways:

Description	Order no.
– Cable with USB-B and USB-A plug	Specialist shops

**USB printer** You can connect a USB printer to the XD 7000:

Description	Order no.
– Cable with USB-B and USB-A plug	Specialist shops

## 9 Appendix

### 9.1 Glossary

<b>Absorbance</b>	Logarithmic dimension for the absorption of the sample; negative decadic logarithm of the transmission.
<b>Analysis instructions</b>	The exact proceeding to carry out the detection procedure is described in the analysis instructions.
<b>AQA</b>	Analytic quality assurance (DeviceCheck).
<b>Barcode</b>	Optical code (black and white bars) of the method that can be read by light barriers in the photometer. The XD 7x00 instruments use two kinds of barcodes. One is on the labels of the 16 mm round cells, the other is a code 128 barcode, which is in the method description and on the reagent packaging.
<b>Baseline</b>	Reference value for the spectrum of reference absorbances or reference transmissions.
<b>Cell</b>	Vessel to take a liquid sample for measurement in a photometer. The cell material (mostly glass) must have certain optical features to be suitable for photometry.
<b>Citation forms</b>	Different display formats that can be derived from each other of the measured value for a concentration. The method for the determination of phosphate, e.g. supplies a measured value for phosphorous P. This measured value can alternatively be given in the citation forms PO <sub>4</sub> , PO <sub>4</sub> -P or P <sub>2</sub> O <sub>5</sub> .
<b>Concentration</b>	Mass or amount of a dissolved substance per volume, e. g. in g/L or mol/L.
<b>Correlation coefficient</b>	Specifies the extent of the linear relationship of value pairs when determining the zero point and slope for a user-defined method.
<b>Detection procedure</b>	The detection procedure designates the general principle of how a sample is brought into a form suitable for measurement. Different methods can be based on the same detection procedure.
<b>DeviceCheck identifier</b>	Measurement values are provided in the documentation with a DeviceCheck identifier (PCheck or MCheck), depending on whether and with which DeviceCheck level the measurement was done.
<b>Kinetics</b>	Measurement over a period of time.
<b>MCheck</b>	Checking of the instrument together with the method in the course of analytic quality assurance
<b>Measured value</b>	The measured value is the special value of a measured parameter to be determined. It is specified as product of numeric value and unit (e. g. 3 m; 0,5 s; 5,2 A; 373,15 K).

<b>Method</b>	<p>A method comprises a chemical detection procedure and special method data (calibration line) required to evaluate the measurement results.</p> <p>How to carry out the method up to measuring with the photometer is described in the analysis instructions.</p> <p>The XD 7000 contains a database with methods. Furthermore, user-defined methods can be entered in the database as well.</p>
<b>PCheck</b>	Checking of the instrument in the course of analytic quality assurance
<b>PhotoCheck standard</b>	Stable color solution with defined absorbance values for the check of the photometer.
<b>Reagent blank value</b>	The evaluation of the photometric measurement always refers to the comparison value of a test sample without the substance to be determined (reagent blank value). Thus the influence of the basic absorbance of the reagents on photometric measurement is compensated for.
<b>Recovery</b>	<p>The recovery rate is the found measured value divided by the default value (percentage).</p> <p>Example: Specified value 20 mg/l; found 19.7 mg/l =&gt; refinding 0.985 or refinding rate 98.5%.</p>
<b>Reference absorbance</b>	With the reference absorbance, the basic absorbance stored in the photometer can be replaced by a measurement of your own.
<b>Reset</b>	Restoring the original condition of all settings of a measuring system.
<b>SCheck</b>	Check of the influence of the sample matrix on the results in the course of analytic quality assurance
<b>Spectrum</b>	Distribution of the intensity, transmission or absorbance depending on the wavelength.
<b>Standard</b>	Sample with a defined concentration of the analyte to be determined.
<b>Test sample</b>	Designation of the test sample ready to be measured. Normally, a test sample is made by processing the original sample. The test sample and original sample are identical if the test sample was not processed.
<b>Test set (test)</b>	A test set contains all reagents that are required for the photometric determination of the sample according to the analysis instructions.
<b>Transmission</b>	The part of the light that goes through the sample.
<b>Turbidity</b>	Light attenuation caused by diffuse scattering at undissolved substances.
<b>ValidCheck®</b>	Standard solutions for checking the method.
<b>Zero adjustment</b>	Adjusting a photometer with a water-filled cell.

## 9.2 List of trademarks

<b>Trademark</b>	<b>Owner</b>
Microsoft®	Microsoft Corporation
Excel®	Microsoft Corporation

## 9.3 Keyword index

### A

Absorbance / % Transmission, measuring	72
Accessories	170
Analysis timer	107

### B

Barcode	40
Barcode reader	22
Blank value	
Reagent blank value	50
Sample blank value	48

### C

Cell breakage	160
Cleaning	158
Commissioning	15
Concentration measurement	40
Connections	11
Copying files	119
Copyright	2

### D

Dataset	110
Date/time	35
Disinfection	158

### G

Glossary	172
----------	-----

### I

Initial commissioning	16
Initialization	151
Instrument settings	34

### K

Keypad	12
Kinetics	95

### M

Measured value memory	111, 112, 113
Measurement dataset	110

Measuring diluted samples	46
Meter information	152
Method	83
Methods update	153
Multi-wavelengths methods	76

### O

Operating elements	11
Operating principles	27
Overview	11

### P

Print	126
Printer	126
Profile (kinetics)	98
Profile (spectrum)	87

### R

Reagent blank value	
Measuring the	51
Reference absorbance	73
Reset	151

### S

Safety	7
Sample blank value	48
Save	109
Scope of delivery	15
Self-test	25
Socket field	11
Software update	153
Software version number	152
Standard adjustment	54
Switching on	25
System info	152
System management	34

### T

Technical data	164
Timer	106
Turbidity correction	61

### U

Update	153
--------	-----

---

USB memory device .....	21
User calibration .....	54
User-defined methods	
Concentration .....	61
Multi wavelengths .....	76

## **Z**

Zero adjustment .....	36
-----------------------	----





**Tintometer GmbH**

Lovibond® Water Testing  
Schleefstraße 8-12  
44287 Dortmund  
Tel.: +49 (0)231/94510-0  
Fax: +49 (0)231/94510-20  
sales@tintometer.de  
www.lovibond.com  
Germany

**The Tintometer Ltd**

Lovibond® House  
Sun Rise Way  
Amesbury  
Salisbury  
SP4 7GR  
Tel.: +44 (0)1980 664800  
Fax: +44 (0)1980 625412  
sales@tintometer.com  
www.lovibond.com  
UK

**Tintometer AG**

Hauptstraße 2  
5212 Hausen AG  
Tel.: +41 (0)56/4422829  
Fax: +41 (0)56/4424121  
info@tintometer.ch  
www.tintometer.ch  
Switzerland

**Tintometer Inc.**

6456 Parkland Drive  
Sarasota, FL 34243  
Tel: 941.756.6410  
Fax: 941.727.9654  
sales@tintometer.us  
www.lovibond.com  
USA

**Tintometer China**

Room 1001, China Life Tower  
16 Chaoyangmenwai Avenue,  
Beijing, 100020  
Tel.: +86 10 85251111 App. 330  
Fax: +86 10 85251001  
China

**Tintometer South East Asia Unit**

B-3-12, BBT One Boulevard,  
Lebuh Nilam 2, Bandar Bukit Tinggi,  
Klang, 41200, Selangor D.E  
Tel.: +60 (0)3 3325 2285/6  
Fax: +60 (0)3 3325 2287  
lovibond.asia@tintometer.com  
www.lovibond.com  
Malaysia

**Tintometer Brasilien**

Caixa Postal: 271  
CEP: 13201-970  
Jundiaí – SP -  
Tel.: +55 (11) 3230-6410  
sales@tintometer.com.br  
www.lovibond.com.br  
Brasil

**Tintometer Indien Pvt. Ltd.**

B-91, A.P.I.E. Sanath Nagar,  
Hyderabad, 500018  
Tel: +91 (0) 40 4647 9911  
Toll Free: 1 800 102 3891  
indiaoffice@tintometer.com  
www.lovibondwater.in  
India

Technische Änderungen vorbehalten  
Printed in Germany 04/2018  
No.: 71310050  
Lovibond® und Tintometer®  
sind eingetragene Warenzeichen  
der Tintometer Firmengruppe

